

ELECTRONICTM

Servicing & Technology

December 1999

Replacement parts/servicing information

Servicing mechanical sub-systems

PROFAK
Hitachi Solid State
Color Television
Model CT7970B1K

Test equipment showcase



Bin Screen fits!

*****3-DIGIT 787
04 00213563 2008 191201AJY
TOM KIPKLAND
5907 IVY HILL DRIVE TX 78759
AUSTIN

U.S. \$3.50

12 >



7 25274 86667 0

CERTIFICATION HEADQUARTERS AT 2000 INTERNATIONAL CES



Your Source for Workstyle
and Lifestyle Technology™

For the first time, the electronics industry is uniting to offer professional certification examinations during the 2000 International CES in Las Vegas, Nevada. The exams are being hosted by the Technical Education and Services department of the Consumer Electronics Association (CEA). Continuing its efforts to ensure professionalism in the workplace, the CEA is offering the Certified Electronics Associate (CEA) exam as the cornerstone of computer delivered exams at the show. Exams from the following organizations will be offered at Certification Headquarters as well:



**Certified
Electronics
Associate**



**Mobile
Electronics
Certification
Program**



**Electronics
Technicians
Association**



**National Association
of Radio and
Telecommunications
Engineers***



**International
Society of
Certified
Electronics
Technicians**

CERTIFICATION HEADQUARTERS

Location:

**The Sands Convention
Center, Rooms 401, 402,
403/Venetian Hotel,
Las Vegas, NV**

Dates & Time of Exams:

January 6th.....10 am-6pm
January 7th.....9 am-6pm
January 8th.....9 am-6pm
January 9th.....9 am-4pm

Examinations Offered:

Consumer Electronics Association (CEA)

- Mobile Electronics Certifications

EIA

- Certified Electronics Associate (CEA)

Electronics Technicians Association (ETA)

- Associate Level Electronic Technician
- Journeyman CET, Consumer Electronics Technician
- Journeyman CET, Audio-Video Distribution Technician
- Journeyman CET, Telecommunications Technician
- Journeyman CET, TVRO Technician
- Computer Service Specialist
- Customer Service Specialist

International Society of Electronics Technicians (ISCET)

- Journeyman, Consumer Option
- Journeyman, Computer Option
- Journeyman, Communications Option
- Journeyman, Industrial Option

Note: All ISCET exams will be Paper-Pencil version

National Association of Radio and Telecommunication Engineers

- FCC Commercial License Exams
- Telecommunications Technician (Class 1-4)
- Telecommunications Engineer Class 1
- Telecommunications Engineer Class 3
- EMC Engineer
- EMC Technician
- ESD Engineer
- ESD Technician

Note: All NARTE exams will be Paper-Pencil version

**FREE REGISTRATION for the 2000 International CES on-line through
December 17, 1999. Visit <http://www.cesweb.org> to register**

Call participating organizations for more information about other exams.

The official CEA Study Guide is available to help you prepare for the CEA exam. This comprehensive, interactive study guide, with "Electronics Workbench" software includes CD-ROM based review modules and sample exams. Call 703-907-7670 to order your copy now. Study Guides are also available for the other exams offered at CES. Please contact the individual organizations for purchasing information.



Circle (113) on Reply Card

contents

FEATURES

- 6 Mechanical sub-assemblies in electronic devices** *by John Ross*
Modern consumer electronics devices contain a variety of mechanical subsystems. This article will consider the mechanical sub-assemblies individually and discuss typical problems and solutions.
- 12 Troubleshooting techniques** *by Sam Goldwasser*
This article will provide some general rules of troubleshooting and provide readers with a general outline of an efficient, effective approach to locating the causes of malfunctions in consumer electronics products.
- 22 Test equipment showcase** *by the ES&T Staff*
This special advertising section is a way to provide information to readers about test equipment in a way that is not ordinarily possible. Advertisers in this special section have been given additional space to tell readers about their companies and products. We invite readers to see what these companies have to say.
- 44 Home automation** *by Jim Van Laarhoven*
Home automation can consist of a myriad of different features. This article will concentrate on lighting, but will mention other areas of integration of one such system.
- 50 Replacement parts/servicing information sourcebook** *by the ES&T Staff*
This annual article provides a number of information tools and updates address listings for some of those hard-to-find parts and service manuals.

DEPARTMENTS

- 2 Editorial
- 4 News
- 5 Literature
- 11 Photofacts
- 19 Test Your Electronics Knowledge
- 20 What Do You Know About Electronics?
- 21 Calendar
- 29 Profax
- 42 Products
- 61 Books
- 62 Classified
- 63 Reader's Exchange
- 64 Advertisers' Index

ON THE COVER

One of the significant developments in consumer electronics in recent years is the large-screen TV. These units come in direct view and projection varieties, and don't forget plasma. With the advent of HDTV, there will be more and more of these behemoths. Test equipment will be the key to diagnosing large screens, as well as all the other products that service centers see, so have a look in our Test Equipment Showcase to see what the participants have to offer. (Photo courtesy Sencore.)



22



6



44

Editorial

by Nils Conrad Persson

If the process of servicing a complex consumer electronics product had to be summed up in one concept, that concept would be “troubleshooting.” Another term for the same thing that we borrow from the medical community is “diagnosis.” In fact, this skill that technicians possess that allows them to encounter a faulty product, perform a combination of tests, manipulations and observations, and on the basis of the results of those actions to draw a logical conclusion as to what the cause of the problem might be, is so important, that this magazine offers articles examining the process on a regular basis. Readers will find a substantial article in this issue examining troubleshooting from a number of angles.

The actual process of troubleshooting is an elusive thing. Some technicians seem to possess some kind of insight that allows them to go right to the heart of the problem. Some of us never do seem to acquire that knack.

Generally, though, I think you’ll find that technicians who are the best at troubleshooting are the people who love electronics. Who love electronics. They’re the people who spend their spare time studying the latest in texts having to do with electronics, who tinker incessantly, who, when faced with a perplexing problem go back and review their grasp of basic electronics and either reinforce that knowledge or alter it. They’re the ones who seem to be able to get their minds into a circuit and almost feel how it works.

Moreover, these technicians who are the most successful at troubleshooting, at diagnosing, the cause of a problem, are the people who can think the most logically: about electronics anyway. They study the condition of an inert piece of equipment; observe it, poke it, test it, and compare their observations against the vast store of electronics that they possess, and are able to generate correct, or nearly correct, hypotheses as to the reason for the product’s failure.

We also suspect that some of the most skillful technicians are those who at some time in their careers have come under the influence of a mentor; someone who is adept at troubleshooting, understands the process, and is able to impart it to an apprentice technician. These mentors are not only technically gifted, but they are also confident. Their combination of skills, and the confidence that their skills will always be in demand allows them to be generous with their help and advice to developing technicians.

We all know about the type of technician who is gifted, but won’t share their knowledge because they’re afraid that if they help someone else, that the person they help will surpass them in competence. The mentors, on the other hand, know that if they help a young, gifted, technician develop, that technician might go beyond them in abilities, but instead of feeling threatened, feel gratified that they can not only help that technician, but by so doing, improve the effectiveness of the service center, and its service to the public.

Unfortunately, not every technician finds a mentor. That’s one of the reasons that **ES&T** regularly publishes articles on troubleshooting. By finding authors who understand troubleshooting, and who are generous enough to share their skills with all of the readers of the magazine, we are able to provide a little of the benefit that a true mentor would.

The article in this issue, by Sam Goldwasser, contains a great deal of good troubleshooting wisdom. One of the most important

parts of the article, we think, is the very first part: the segment that deals with safety, making mistakes (and how to avoid that), looking for the simple answer to a problem, and sleeping on a problem that seems particularly knotty.

Because we think they’re so important, we’ll mention some of them here. The most important of these rules is *safety first*. Always know the hazards associated with the equipment you are troubleshooting. It never hurts to reread the safety information provided by the manufacturer. It’s important or they wouldn’t include it in the documentation. Take all safety precautions. Expect the unexpected. Take your time.

Another important consideration is to always think “what if?” This element applies both to the analytic procedures as well as to precautions with respect to probing the equipment.

And while it may sound pretty basic, the advice to learn from your mistakes is an important bit of advice. We all make mistakes. Some of them can be quite costly. Unfortunately, we don’t always, necessarily, learn from those mistakes.

The temptation is always there to jump right in with the DMM or the oscilloscope, but troubleshooting is usually more fruitful if you start with some analytical thinking. And along those same lines, if you get stuck, sleep on it. Sometimes, just letting the problem bounce around in your head will lead to a different more successful approach or solution. And never work when you are really tired. The potential for damaging equipment, or causing injury to yourself is multiplied many fold when you’re tired.

If your instruments give you readings that you don’t believe, maybe those readings are incorrect. You may be using your equipment in a way that is confusing it. As examples, DMMs are not good at checking semiconductors in-circuit, or the power transistor you are testing may have a built-in damper diode and/or base resistor. Your scope may be picking up interference which is swamping the low level signal you are searching for (TVs and monitors, or low level circuits in VCRs and CD players). Your frequency counter may be double triggering due to noise or imperfect signal shape.

Confirm the problem before diving into the repair.

Always make notes and diagrams during a service procedure. They’ll help you immeasurably when the time comes to reassemble the unit. And you may encounter another similar unit someday, and those notes, if you file them with the service literature, will come in handy.

We hope that the troubleshooting suggestions you find in the article in this issue are useful.

Since we’ve spoken of the generosity of mentors in general, and the author of the troubleshooting article in this issue in particular, we should also call attention to the generosity of all the authors who regularly contribute articles to **ES&T**. They receive a little money for their efforts. But their primary motivation is to share their experiences with other technicians.

I won’t try to name them here. There are too many, and I’d hate to leave any of them out. You know who they are, I know who they are, and they know who they are, and readers of this magazine have received a great deal of benefit from their generosity and their writings. Thanks guys.

THE PROFESSIONAL MAGAZINE FOR ELECTRONICS AND COMPUTER SERVICING

ELECTRONIC

Servicing & Technology

Electronic Servicing & Technology is edited for servicing professionals who service consumer electronics equipment. This includes service technicians, field service personnel and avid servicing enthusiasts who repair and maintain audio, video, computer and other consumer electronics equipment.

EDITORIAL

Nils Conrad Persson, *Editor*
(Internet e-mail: cpersedit@aol.com)
Alycia Nicholsons, *Associate Editor*
(Internet e-mail: AlyciaEST@aol.com)
Richard S. Moseson, W2VU, *On-Line Coordinator*

CONSULTING EDITORS

Homer L. Davidson, *TV Servicing Consultant*
Victor Meeldijk, *Components Consultant*
John E. Shepler, *Audio Consultant*
Sam Wilson, *Electronics Theory Consultant*

PRODUCTION

Elizabeth Ryan, *Art Director*
Barbara McGowan, *Associate Art Director*
Edmond Pesonen, *Electronic Composition Mgr.*
Dorothy Kehrwieler, *Production Manager*
Emily Leary, *Assistant Production Manager*
Pat Le Blanc, *Phototypographer*

BUSINESS

Richard A. Ross, *Publisher*
Sal Del Grosso, *Accounting Manager*
Ann Marie DeMeo, *Accounting Department*
Judith Erickson, *Office Manager*
Catherine Ross, *Circulation Manager*
Melissa Gilligan, *Operations Manager*
Denise Kells, *Data Processing*
Jennifer Cormagi, *Customer Service*

ADVERTISING SALES OFFICE

Kaprelian & Company, Inc.
521 Illinois Avenue, St. Charles, IL 60174
Tel.: 630-584-5333 Ext. 10 • Fax: 630-584-9289

Bill Kaprelian, *Director of Advertising*
Emily Leary, *Sales Assistant*

EDITORIAL CORRESPONDENCE:

P.O. Box 12487
Overland Park, KS 66212
913-492-4857



National Electronics Service
NESDA
Dealers Association, Inc.
Member, Electronic Servicing
Dealers Association

Electronic Servicing & Technology (ISSN 0278-9922) is published 12 times a year by CQ Communications, Inc. 25 Newbridge Road, Hicksville, NY 11801. Telephone (516) 681-2922. Periodical class postage paid at Hicksville, NY and additional offices. Subscription prices (payable in US dollars only): Domestic—one year \$26.95, two years \$49.95. Canadian—one year \$36.95, two years \$69.95. Foreign Air Post—one year \$44.95, two years \$85.95. Entire contents copyright 1999 by CQ Communications, Inc. Electronic Servicing & Technology or CQ Communications, Inc. assumes no responsibility for unsolicited manuscripts. Allow six weeks for delivery of first issue and for change of address. Printed in the United States of America.

Postmaster: Please send change of address notice to Electronic Servicing & Technology, 25 Newbridge Road, Hicksville, NY 11801.

CQ Communications, Inc. is publisher of CQ The Radio Amateur's Journal, Popular Communications, CQ Radio Amateur (Spanish CQ), CQ VHF, CQ Contest, and Electronic Servicing & Technology.



B&D

ENTERPRISES

AUTHORIZED DISTRIBUTOR FOR

NEC **Shindengen**

SANYO **Sanken** AND OTHERS

NEW

A Bell Atlantic Company

Howard W. Sams

Authorized distributor

- Photofacts • VCR facts
- Photofact of the month subscriptions
- Prompt publications • U-Can Do Videos



Visit our
Website at
www.bdent.com

- Secure server on-line ordering
- Manufacturers' catalogs and data sheets
- Competitive pricing with over 16,000 components in our on-line database

P.O. Box 460 Main & Liberty, Russell, PA 16345

TECH SUPPORT: 814-757-8300

FAX: 814-757-5400

Call today for your FREE Catalog

1-888-815-0508

Circle (60) on Reply Card

CEMA Certified Electronics Associate (CEA) exam honored with Award of Excellence

The Consumer Electronics Manufacturers Association (CEMA) received the American Society of Association Executives (ASAE) Award of Excellence for its Certified Electronics Associate (CEA) exam, which certifies electronics professionals on the knowledge and practice of electronics servicing and manufacturing. Those who pass the exam possess the knowledge and abilities to succeed in the highly competitive international electronics marketplace, including the consumer, component, industrial, government, medical, and telecommunications electronics industries.

The CEA exam is the culmination of efforts begun in 1992 to identify and implement national skill standards in education. In cooperation with the Department of Education, the Electronics Industries Alliance, the Electronics Industries Foundation, and CEMA initiated the effort to develop a set of skill standards agreed upon by industry and education alike.

Now in its ninth year, the Award of Excellence, sponsored by ASAE, is presented to associations that foster ASAE's Advance America theme with innovative projects in education, skills training, standards-setting, business and social innovation, knowledge creation, citizenship, and community service.

"We are very pleased to be recognized for identifying the need for certified electronics professionals and for providing a standard of measurement for their level of skill," said Don Hatton, vice president of Technical Education and Services for CEMA. "Projections indicate that U.S. electronics industry sales will reach nearly \$825 billion by 2005 and qualified technicians will be needed to meet the service needs that increase represents."

The CEA program was implemented in September 1998. Since then, it has been approved as a prerequisite for the International Society of Certified Electronic Technician's Journeyman Certified Electronics Technician exam, the Electronic Technicians Association's professional and specialty exams, and by the American Council on Education for college credit.

FCC reaffirms timetable for set-top box retail availability

The Consumer Electronics Manufacturers Association (CEMA) has expressed support for the Federal Communications Commission (FCC) decision reaffirming the timetable for the commercial availability of set-top boxes or "navigation devices."

"We are pleased that the FCC chose to reaffirm its pro-consumer, pro-competitive timetable in this proceeding. A competitive market in cable set-top boxes is long overdue," said CEMA President Gary Shapiro.

"This ruling will ensure that Americans have the ability to choose their cable set-top boxes, as they are able to choose every other consumer electronics product. Retail availability means more competition, more innovation, and lower prices for American consumers."

The Commission's decision requires cable providers to have separate security and non-security functions from cable set-top boxes by July 1 of 2000, and prohibits the provision of set-top boxes with integrated security after January 1, 2005. The

Commission's Order applies to digital and digital-analog "hybrid" boxes, and exempts analog-only devices. The decision is the FCC response to petitions for reconsideration filed by various parties after the FCC released its initial order in this proceeding on June 24, 1998.

"CEMA agrees with the Commission's decision to exempt analog-only equipment from its rules in this proceeding," Shapiro noted. "This exemption, by limiting cable's obligations solely to digital and hybrid devices, should allow cable to phase out its use of integrated security well in advance of the Commission's deadline of January 1, 2005. We urge the cable industry to begin transitioning their inventory from integrated to non-integrated boxes as soon as separate security modules become available."

Six nationally recognized certification exams offered at the 2000 International CES

Organizations representing various facets of the electronics industry are uniting to offer an unprecedented collection of professional electronics certification exams during the first ever "Certification Headquarters." The program, hosted by the 2000 International CES in Las Vegas, Nevada, January 6-9, 2000, is the largest collection of such exams ever offered during a single event.

"Certification is central to the vitality of individuals, employers and educational institutions of the electronics community, and CES is proud to host the certification efforts of six nationally recognized programs," explained Robbi Lycett, CES vice president.

In the Consumer Electronics Manufacturers Association's (CEMA) continuing efforts to ensure professionalism in the workplace, the CEA (Certified Electronics Associate) exam will be the cornerstone of the computer-delivered examinations. As the sponsor, producer and manager of CES, CEMA also has invited several other electronics associations to participate in delivering a wide range of professional certifications that will include:

- CEA
 - Electronic Technicians Association (ETA)
 - International Society of Certified Electronics Technicians (ISCET)
 - Mobile Electronics Certified Professional (MECP) Program
 - National Association of Radio and Television Engineers (NARTE)
 - National Electronics Service Dealers Association (NESDA)
- The exams will be held during show hours at the Sands Expo/Venetian.

To prepare for the CEA exam, an official CEA Study Guide is available that covers all key content areas of the test. The study guide includes thousands of illustrations, more than 400 questions and answers to reinforce the student's learning, and an interactive CD-ROM of Electronics Workbench. To order the study guide, call 703-907-7670.

For information about specific exams, registration details and exam costs, visit the CEMA's Website, www.CEMAcity.org/works. For more news on CES before, during and after the show, visit www.CESweb.org, the interactive source for CES news and information. ■

Literature

Data acquisition product catalog

United Electronic Industries new PowerDAQ 2000 Product Catalog offers innovations in data acquisition, focusing on

"Quality of Measurement," 25 new PCI based data acquisition products and high speed streaming to disk solutions for Windows 95/98/NT.

Featured articles/products in the catalog include: Quality of Measurement — what users should expect from data acquisition vendors, innovations, sample and hold A/D boards, high channel count D/A boards, high

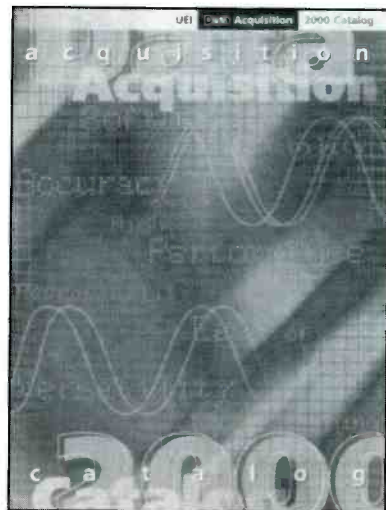

density DIO boards, offering LabVIEW users more choices.

In addition, the catalog features extensive analog and digital signal conditioning products, software support for LabVIEW, HP VEE, DIAFem, TestPoint, and DASTLab.

United Electronic Industries, 10 Dexter Avenue, Watertown, MA 02472,
Phone: 617-924-1155, Fax: 617-924-1441, Website: www.ueidaq.com

Circle (90) on Reply Card

Inventory locator Website

Richardson Electronics has added PowerFind.net to its roster of internet inventory locator sites.

PowerFind, launched in August, allows buyers and engineers to locate and compare electronic components free of charge. Customers can search the database by entering a part number. PowerFind then displays the distributors that carry the desired part and the stocked quantities. The customer may click on the preferred distributor to be linked to that distributor's website.

Besides inventory listings at PowerFind.net and an on-line catalog at catalog.rell.com, the company utilizes the following online inventory sites: brokerforum.com, stknet.com, and eurobase.net.

Richardson Electronics, 40267 Keslinger Road, P.O. Box 393, LaFox, IL 60147-0393,
Phone: 800-348-5580, Fax: 630-208-2550, E-mail: info@rell.com, Website:
www.rell.com

Circle (91) on Reply Card

Catalog supplement

Contact East offers its Spring Service Supplement featuring products for testing, repairing, and maintaining electrical and electronic equipment. Products highlighted in this issue include the latest DMMs and oscilloscopes, power supplies, cable testers, tool cases, shipping containers, label printers, precision

hand tools, cordless drivers, telecom test sets, magnifiers, soldering supplies, adhesives, ESD protection equipment, and much more. Some of the featured products include four varieties of Huntron Trackers and a full selection of Harris butt-in test sets. Also included is a 16 page insert of standard, custom, and modifiable tool kits. Brands include Fluke, Tektronix, Hewlett Packard, Huntron, BK Precision, APC, Harris, Ideal, Brady, Xcelite, Lindstrom, Weller, Pace, Hakko, Loctite, and 3M.

Contact East, 225 Willow Street, North Andover, MA 01845, Phone: 978-682-2000,
Fax: 978-688-7829, Website: www.contacteast.com

Circle (92) on Reply Card

Master tools catalog

Jensen Tools has released a redesigned and expanded Master Sourcebook for 1999/2000. This full color catalog contains

many new products, including the new line of JTS test sets and the recently introduced line of Jensen hand held meters.

In addition to over 160 pages of the company's tool kits, the new catalog features test equipment, an extensive selection of hand tools, power and specialty tools, wire and cable, soldering equipment, computer and LAN

products, storage and handling equipment, workstations, lighting and optical, shop supplies, communications products and more.

Jensen Tools, 7815 S. 46th Street, Phoenix, AZ 85044, Phone: 800-426-1194,
Fax: 800-366-9662, E-mail: jensen@stanleyworks.com, Website: www.jensentools.com

Circle (93) on Reply Card



Supplement to semiconductor replacement guide

The new Semiconductor Master Replacement Guide Supplement (ET-2863-S1) from Philips ECG features 81 new components and over 4,400 new crosses that compliments the 18th Edition Master Replacement Guide ECG212T.

The master replacement guide and supplement now contains technical specifications and crosses for over 304,000 industrial part numbers. The updates Instant Cross program (ET-2604W 2.1) is also now available.

Philips ECG, 1001 Snapps Ferry Road, Greenville, TN 37744, Phone: 1-800-526-9354,
Website: www.ecgproducts.com

Circle (94) on Reply Card

Mechanical sub-assemblies in electronic devices

by John A. Ross

When I began servicing consumer electronics devices 26 years ago, I often had to repair turntables, 8-track players, and cassette players. Those devices featured a multitude of belts, gears, pulleys, motors, solenoids, levers, and slides. If the mechanisms operated as promised, the turntable or 8-track player would produce hi-fidelity sound to the consumer's satisfaction. More often than not, however, a worn tire, stretched belt, or dirty slide mechanism would cause the device to produce inferior audio with symptoms such as wow and flutter. In some instances, the device would fail to function.

All this seems like ancient history. However, when we "fast forward" to our experience with modern consumer electronics devices, we find that many of those devices contain a variety of mechanical subsystems. Although the gears, motors, and slides have become smaller and more dependable, problems still occur with the mechanical portions of electronic systems. As with any type of electronics repair, knowing about the operation of the device and the symptoms of a failure exists as the key ingredient for problem solving. Without that knowledge, troubleshooting becomes nothing more than a hit-or-miss proposition. This article will consider the mechanical subsystems individually and discuss typical problems and solutions.

Motors and motor control operation

Modern electronic systems rely on brushless dc motors that do not require the use of a commutator and have specially-designed armatures. In turn, the armature has a doughnut shape that magnetically divides into sectors. Field coils attached to a printed circuit board energize sequentially and pull the armature in a circle.

Figure 1 shows a picture of the field coils from a capstan motor found in a VCR.

The mechanical load placed on the motor determines the amount of current flowing through the armature. Controlling the motor speed may involve one of three factors:

- control of the field current,
- adding resistance in series with the armature, and
- changing the terminal voltage at the motor.

Most systems rely on some method for controlling the terminal voltage. For systems using this scheme, the increase or decrease of the voltage affects the speed of the motor.

Control circuitry

With servo motors, circuitry controls the rotational speed of the motor while using a stable reference signal to control the synchronization of the armature. A servo system is a negative feedback loop control circuit that:

- uses a transducer to sense the condition of the system,

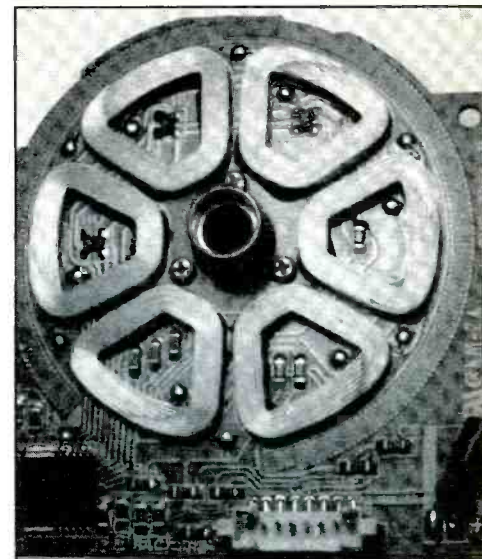

Figure 1. Field coils from a capstan motor found in a typical VCR.

- compares that condition to a reference signal, and
- generates a correction signal to maintain the synchronization.

Generally, the output of a comparator controls a power amplifier that determines the speed of the motor.

As an example of servo control, we can consider the playback function of a VCR.

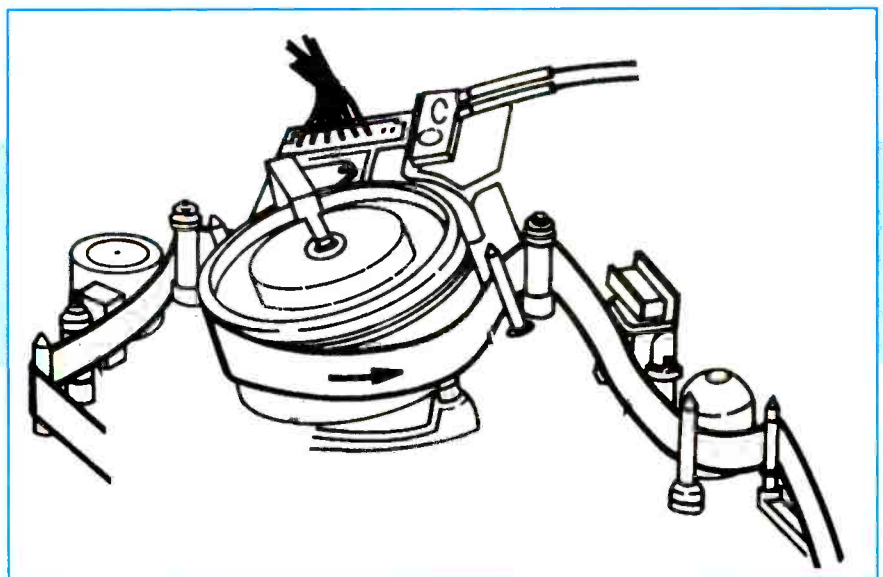

Figure 2. A VCR relies on the capstan motor for pulling the tape through the tape path and the head drum motor to spin the video heads at the correct velocity.

Ross is a technical writer and microcomputer consultant for Ft. Hays State University, Hays, KS.

The capstan servo circuit relies on the operation of a comparator, a pulse width modulator, and an integrator to control the capstan motor speed. During operation, the speed comparator utilizes the vertical sync signal from the incoming video signal and the capstan frequency generator signal as reference signals. After amplification, the frequency generator signal is applied to the comparator. In turn, the output from the comparator controls a pulse width modulator.

Any slowing of the motor causes the comparator output to change and increase the duty cycle of the pulse width modulator. When this occurs, an integrator that has the task of smoothing the square wave signal from the pulse width modulator into a dc voltage has a higher dc output that produces greater drive for the motor. If the motor speed increases, the opposite occurs, and it is slowed down.

Examples of motor applications

VCRs, CD players, DVD players, turntables, and satellite dish systems rely on dc motors. Moving to the example

shown in **Figure 2**, a VCR relies on the capstan motor for pulling the tape through the tape path and the head drum motor to spin the video heads at the correct velocity. Shown in **Figure 3**, compact and digital video disc players use a spindle motor to move the optical disk at the proper speed. Servo systems may control the speed or synchronization of a capstan or drum or position the head in a disc player.

In C-band satellite systems, one motor controls the positioning of the dish as it tracks along the satellite arc while another switches the polarity of the antenna. An actuator consists of a motor and gear assembly and mechanically drives the dish antenna east or west across the satellite arc. Actuators may take the form of linear drive designs or horizon-to-horizon drive designs and feature different types of gear or screw assemblies. In **Figure 4**, a linear drive actuator utilizes a telescoping arm that moves within a fixed tube. While one end of the linear actuator attaches to the mount, the other end attaches to a bracket located on the dish.

Again considering C-band satellite sys-

tems, the servo motor found in a polarator turns the resonant probe located in the feed assembly. During operation, the servo motor relies on a dc voltage supply, a ground connection, and a pulse width voltage that switches the supply across the motor. As the pulse width modulator switches the supply, the probe moves from one polarization format to another. Each pulse is applied for a fixed amount of time and determines how far the resonant probe will move.

Part of the check of the spindle motor in a CD or DVD player involves checking the spindle bearing for any side-to-side play. Worn spindle bearings allows the spindle platform to jiggle slightly. If you run across a spindle motor that has worn bearings, replace the motor. Some products, such as the Sony Discman, do not use a standard permanent magnet motor to drive the spindle and have a bearing runout adjustment screw on the bottom of the spindle. In some cases, a slight adjustment of the bearing runout screw will repair a slight spindle problem.

Gears

Most modern VCRs use gears rather than rubber idler tires to drive the feed and take-up reels. As shown in **Figure 5**, small gears transfer motion from the main loading gear that controls forward and reverse movements of the cassette loading mechanism. **Figure 6** shows the gears used for another type of cassette loading assembly. Along with those applications, drive gears may also work as part of the fast forward and rewind function of a VCR. In these systems, the gear interacts with the brakes that stop the tape mechanism. In addition to applications for VCRs, gear assemblies also open and close the drawer in a CD-ROM and transfer motion from the motor in a satellite system actuator.

Lever and slide assemblies

As mentioned, many different types of equipment rely on sliding mechanisms

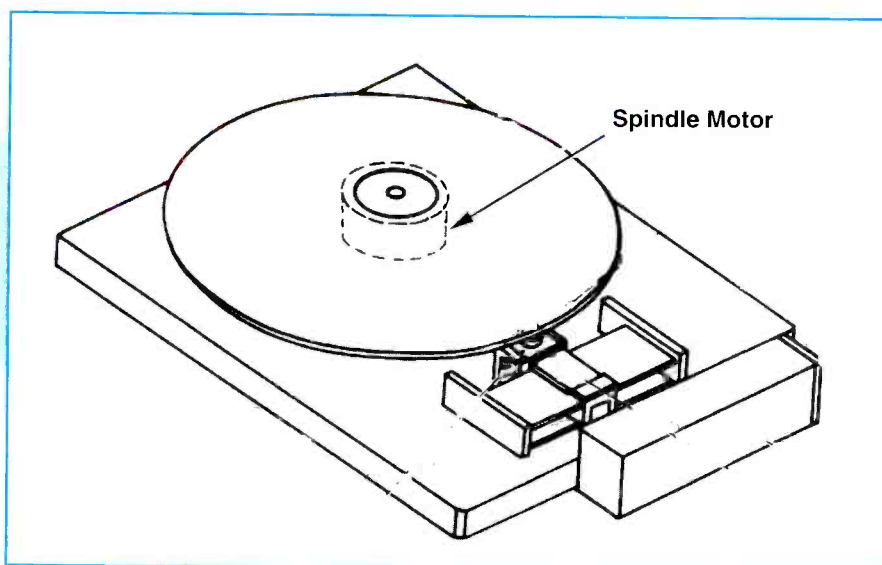

Figure 3. Compact and digital video disc players use a spindle motor to move the optical disk at the proper speed. Servo systems may control the speed or synchronization of a capstan or drum or position the head in a disc player.

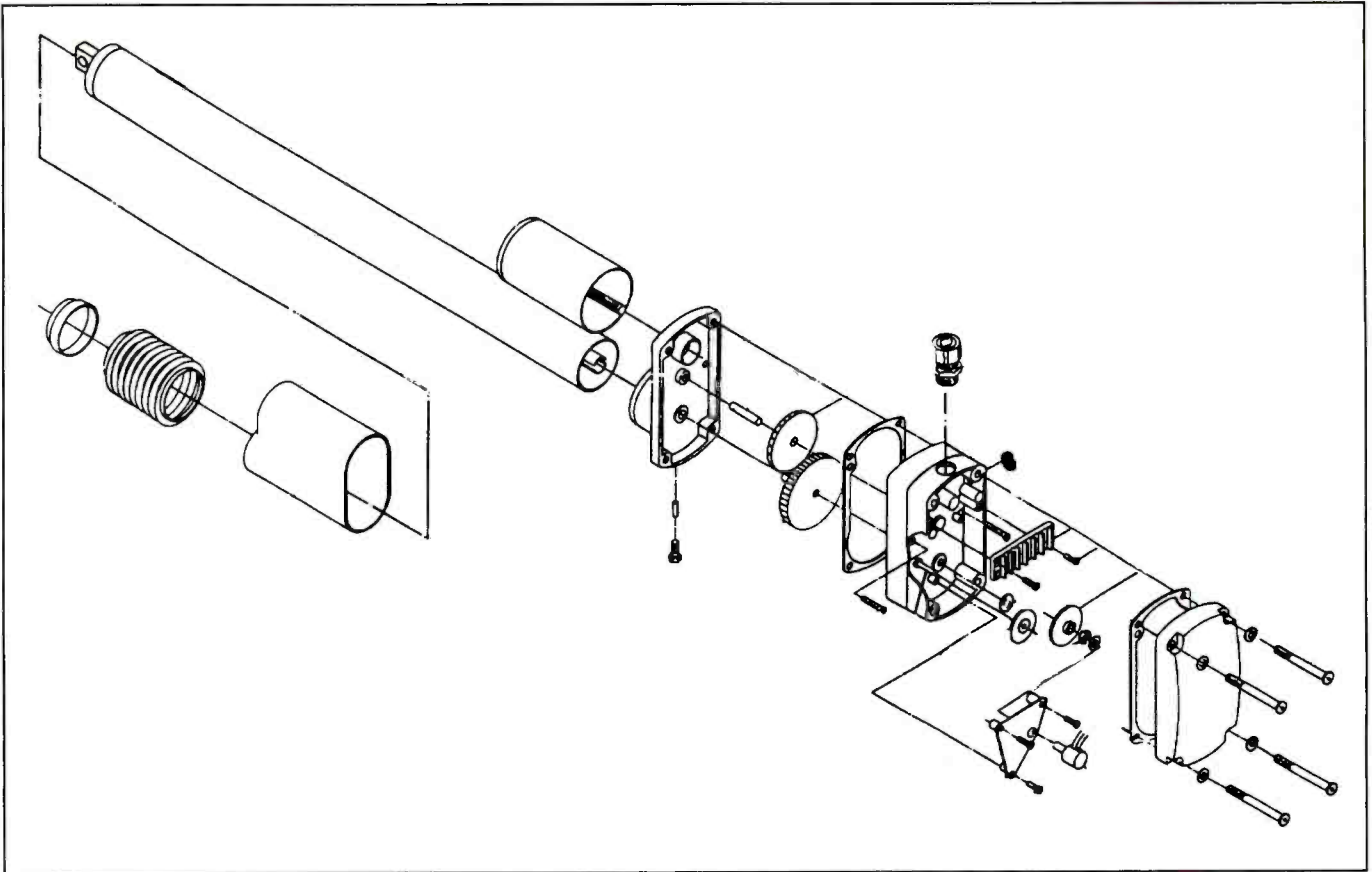

Figure 4. A linear drive actuator utilizes a telescoping arm that moves within a fixed tube. While one end of the linear actuator attaches to the mount, the other end attaches to a bracket located on the dish.

and levers during normal operation. As an example, a scanner operates because of the mechanism that moves the optical unit along the length of the device. VCRs, disc players, turntables, and actuators are other examples where mechanical assemblies provide critical functions.

In any of those devices, general preventive maintenance can protect equipment from failure or when erratic behavior becomes apparent. For mechanical subsystems of this type, careful cleaning and lubrication can solve many problems. As you know, however, excess lubrication can cause considerable damage. In addition, never use strong abrasives or solvents on the mechanisms. A few drops of a solvent in the wrong place can ruin a plastic carriage or destroy a pick-up lens in a disc player.

When working with slide or lever assemblies, always consider the following suggestions:

- Gently remove dust particles from the assembly. Most parts warehouses offer low-power vacuum cleaners for this purpose.

- Clean the surface before applying the new lubricant. Use electronic cleaners to dissolve any dried lubricants and gently dry the surface.

- Do not add any oil or grease unless you are positive that additional lubrication is needed. Most moving parts in electronic devices have received lifetime lubrication at the factory.

- Use lubricants intended for electronic devices rather than off-the-shelf products such as WD-40. A light machine oil will work for gear or wheel shafts while silicone grease is a good answer for gears and cams.

- Never over-lubricate a mechanical subsystem. In most cases, over-lubrication will cause as much as damage as no lubrication.

- Never apply oil or grease to electrical contacts.

Examples of lever and slide assemblies

Several examples of lever and slide assemblies quickly come to mind. The drawer for a CD-ROM or DVD drive in

a computer system functions through the combined actions of gears and a slide assembly. In addition, the CD-ROM and DVD drives also utilize a sled drive that moves the head across the disc. Any type of lever or slide assembly should move freely. During your preliminary inspection, look for damage to any components that might impede free movement. As with other mechanical assemblies, carefully clean any drive surface. Then, lubricate with just a dab of high-quality light grease intended for electronic devices.

Referring to **Figure 7**, some VCRs feature a latching mechanism that controls the brakes during fast forward and rewind. As the figure shows, this particular latching mechanism features a combination of springs, pulleys, pins, and slides. In the latched position, the mechanism holds the brakes away from the drive gears.

Belts

Electronic devices such as VCRs, audio cassette players, and disc players, have a variety of applications for rubber

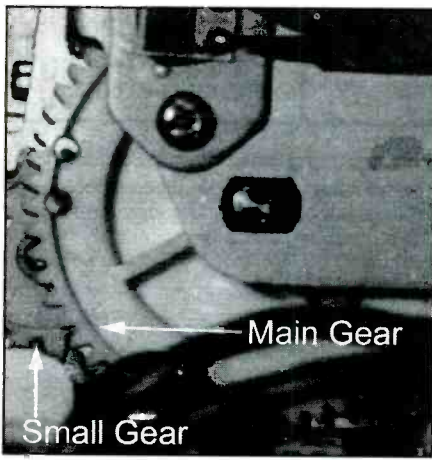

Figure 5. In a VCR, small gears transfer motion from the main loading gear that controls forward and reverse movements of the cassette loading mechanism.

belts. Using a generic VCR as an example, and depending on the age of the machine, many different types of belts provide common functions. A main loading belt or a sub-loading belt in some VCRs works in every mode of VCR operation. If the belt slips in this application, the VCR may not have the fast forward or rewind functions. Moving to **Figure 8**, other VCRs may utilize a Main/FF/RWD belt that attaches between the capstan motor and the clutch assembly. In this application, the belt provides the drive for the reels in the FF/RWD, Play, search, and the unloading modes of operation. If the

Main/FF/RWD belt begins to slip, the video tape will spill or the fast forward will have a slow start.

Access to the belts used in most VCRs will probably require the removal of the bottom cover. After noting the location and path of each belt, remove the belts one-by-one. Preventive maintenance involves inspecting the belts for wear. A worn belt will seem shiny on the drive surface or may appear stretched. Symptoms of a worn belt include servo problems such as intermittent speed control. If the belt seems okay, clean with alcohol and Q-tips or lint free cloth. After cleaning a belt, dry it quickly to avoid degrading the rubber from contact with the alcohol. If a belt is trapped by some assembly and not easy to remove, use the Q-tip on the belt and/or pulley in place.

In some instances, simply cleaning the belt and the drive surface for the belt will solve the problem.

Here are a few common rules of thumb when working with belts. If a belt seems stretched, flabby, or damaged, replace it. If you replace one belt, replace all the belts in the unit. When replacing a belt, ensure that no twists occur when installing the belt on its pulleys.

Rollers and tires

Devices such as VCRs and audio cassette players also utilize various rollers

and rubber tires. Preventive maintenance of these components includes the cleaning of all the guideposts, wheels, and rubber parts. Going back to **Figure 2**, the tape path in a VCR includes roller guides and pinch rollers. The roller guides consist of white rollers on metal posts and are located near the video head drum during the record or play mode for the VCR.

When the VCR operates in the FF or REW mode or does not have a loaded tape, the roller guides move on tracks to a position towards the front of the VCR. In the unloaded position, the rollers should remain loose. During playback or recording, though, the roller guides will fit snugly against the stoppers found at the end of the tracks.

Capstan and pinch rollers collect oxide residue from the tape as it travels along the tape path. The pinch roller presses against the capstan during the play, record, and search modes. Preliminary maintenance steps should include the use of Q-tips and a cleaning solution for the removal of all foreign matter from the rollers and the capstan shaft. If the pinch roller appears hard, shiny, or cracked, replace the roller.

Idler tires are another consistent problem for many older VCRs. The idler tire swings between reels and transfers motor power to the reels. As with the pinch rollers, clean the idler tires with a Q-tip and cleaning solution. Again, if the idler

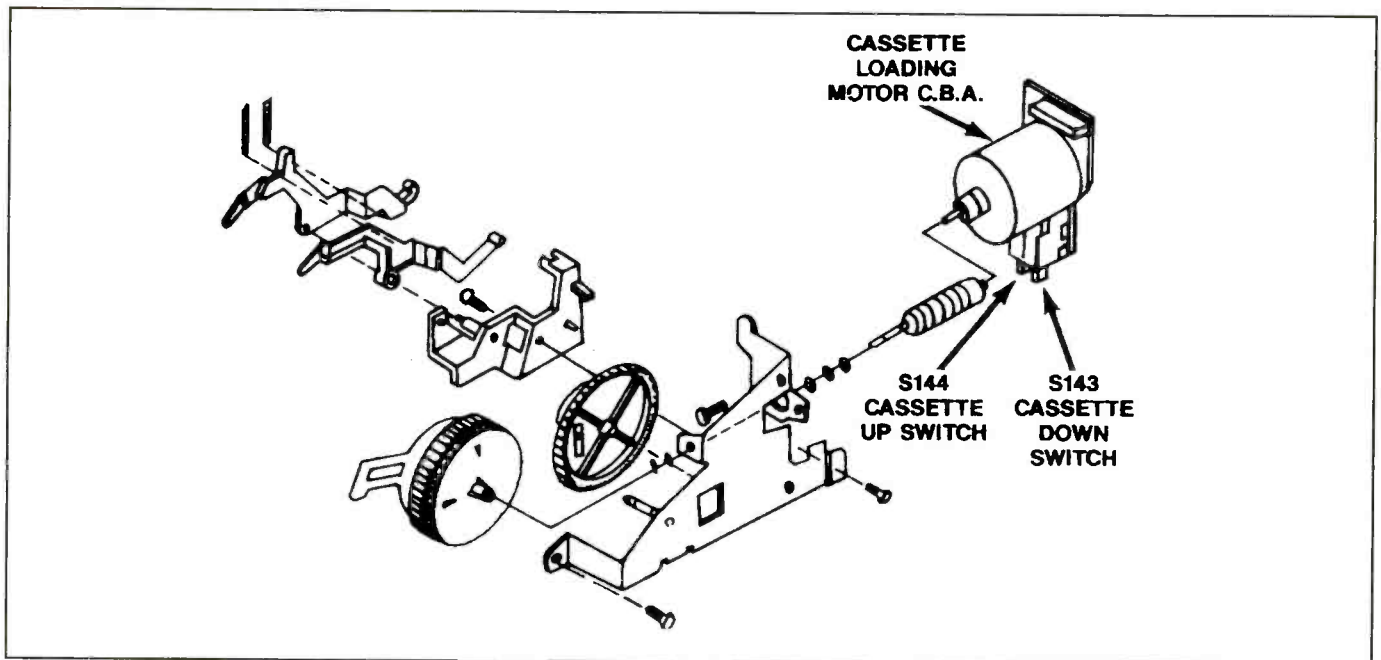

Figure 6. Gears used for a different type of cassette loading assembly.



Your Ticket to **SUCCESS**

More than 40,000 technicians worldwide are Certified Electronics Technicians. IS CET offers Journeyman certification in Consumer Electronics, Industrial, Medical, Communications, Radar, Computer and Video. For more information, contact the International Society of Certified Electronics Technicians, 2708 West Berry Street, Fort Worth TX 76109; (817) 921-9101.

Name _____
 Address _____
 City _____
 State _____ ZIP _____

___ Send material about IS CET and becoming certified
 ___ Send one "Study Guide for the Associate Level CET Test." Enclosed is \$14.95 (includes postage/handling). *TX residents — include 8.25% sales tax.*

ES&T

Circle (75) on Reply Card

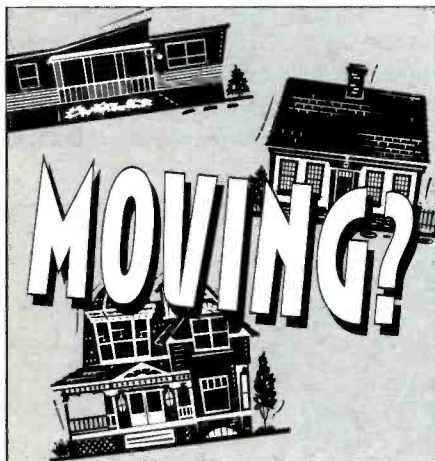

If you're planning a move in the near future, don't risk missing an issue of **Electronic Servicing & Technology**. Please give us 6-8 weeks notice if you're planning on changing your address. Just send us your new address WITH YOUR SUBSCRIPTION MAILING LABEL, to:

Electronic Servicing & Technology

25 Newbridge Road
 Hicksville, New York 11801
 Phone: 1-516-681-2922
 For Faster Service
 FAX: 1-516-681-2926

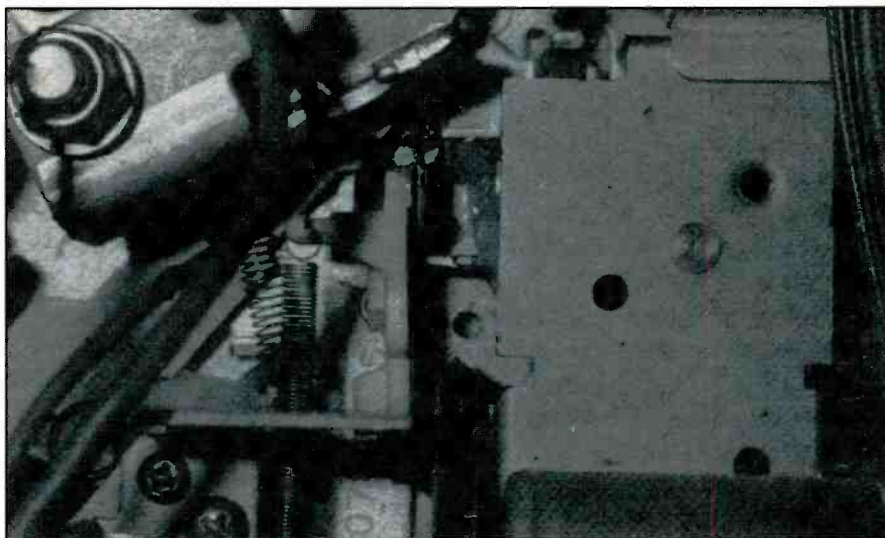

Figure 7. Some VCRs feature a latching mechanism that controls the brakes during fast forward and rewind. As the figure shows, this particular latching mechanism features a combination of springs, pulleys, pins, and slides. In the latched position, the mechanism holds the brakes away from the drive gears.

tire appears cracked, glazed, or dried out, replace the idler tire assembly. The assembly usually includes both the idler tire and a slip clutch. A weak slip clutch will not provide the force necessary to keep the tire pressed against the edges of the reel. A clutch that works too tightly can cause audio and video distortion or may cause damage to the tape.

Summary

As the article shows, electronic devices that rely on electromechanical assemblies often use variations on a theme. The same principles for dc motors, gears, belts,

slides, and tires apply whether the device is a VCR, compact disc, DVD, or satellite dish actuator. While preventive maintenance, such as periodically cleaning and lubricating moving parts can protect against failure, that maintenance also requires the use of common sense. Using harsh abrasives or over-lubricating an assembly can produce more problems. Many times, the practiced eye can function as the best piece of test equipment. Along with applying common sense towards electromechanical repairs, having knowledge about how the mechanism operates also saves time and effort. ■

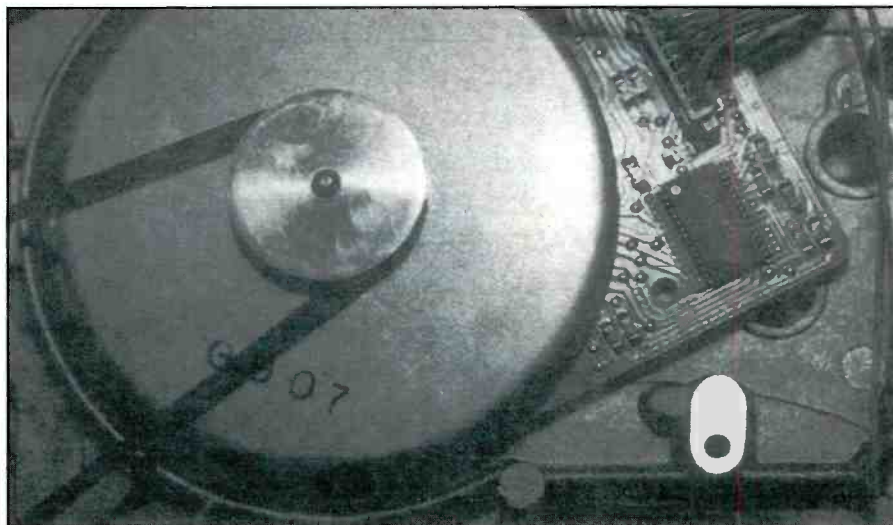

Figure 8. Some VCRs may use a Main/FF/RWD belt that attaches between the capstan motor and the clutch assembly.

Photofacts

November-December 1999

DAEWOO			
CN-001A	4213	
DTQ-19P2FC	4213	
DTQ-19P3FC	4213	
FUNAI			
F4813U	4224	
GE			
CTC185A3	4220	
19GT317TX1	4220	
19GT319TX1	4220	
19GT320TX1	4220	
JVC			
AV-32950	4212	
AV-32950A	4212	
AV-36950	4212	
C-13010	4230	
C-13011	4230	
MEMOREX			
MT1091	4211	
PANASONIC			
AEDP311	4214	
AEDP314	4214	
AP331	4227	
APED319	4232	
APEDP319	4232	
CT-27G33CW	4214	
CT-27G33UW	4214	
CT-27G33W	4214	
CT-32G4A	4227	
CT-32G4UA	4227	
CT-32G14A	4227	
CT-32G14CA	4227	
CT-32G14UA	4227	
CT-32G33CW	4214	
CT-32G33UW	4214	
CT-32G33W	4214	
CT-32SF35W	4232	
CT-32XF35CW	4232	
FP331	4227	
RCA			
CTC185C2	4219	
CTC185C3	4219	
CTC197AH	4229	
CTC203CX	4208	
F19205GYTX2	4219	
F19206BKTX2	4219	
F19207BCTX2	4219	
F27680GYFE1	4229	
F31665YX1	4208	
F32665YX1	4208	
F36665YX1	4208	
G32665YX1	4208	
G35665YX1	4208	
VR538	VCR-316	
VR539	VCR-316	
VR564	VCR-315	
VR654HF	VCR-315	
VR691HF	VCR-315	
SAMSUNG			
TXJ2060	4228	
TXJ2066	4216	
TXJ2067/UCX	4216	
SANYO			
AVM-1309G	4225	
AVM-1309S	4225	
G6L-1309GO	4225	
G6L-1309SO	4225	
SHARP			
CL13M10	4233	
CL13M15	4233	
CL25S18	4217	
CL27S10	4231	
CL27S18	4231	
CL32S40	4226	
CL36S40	4215	
13L-M100	4233	
13L-M150	4233	
25L-M100	4222	
25L-M180	4222	
25L-S100	4217	
25L-S180	4217	
27L-S100	4231	
27L-S180	4231	
32L-S400	4226	
36L-S400	4215	
SONY			
KV-27V40	4210	
KV-32V65	4221	
KV-34VL65	4221	
KV-34VL65C	4221	
KV-35V65	4221	
KV-37VL65	4221	
KV-37VL65C	4221	
SCC-S01L-A	4210	
SCC-S03H-A	4210	
SCC-S08D-A	4221	
SCC-S08G-A	4221	
SCC-S09D-A	4221	
SCC-S09E-A	4221	
SCC-S09G-A	4221	
SCC-S09H-A	4221	
TOSHIBA			
CZ19M21	4209	
CZ27T31	4218	
TAC990	4209	
TAC9905	4218	
ZENITH			
A27A76R	4223	

Troubleshooting techniques

by Samuel Goldwasser

Website: www.repairfaq.org

E-mail: sam@stdavids.picker.com

Troubleshooting of any kind of defective product is (or should be) first and foremost a logical thought process. All the fancy tools and test equipment in the world won't do the technician any good unless he has thought through the nature of the problem, and determined where the cause of the problem most likely is located.

This article will provide some general rules of troubleshooting, including some tips and rules on safety, and will provide readers with a general outline of an efficient, effective, approach to locating the causes of malfunctions in consumer electronics products.

Some rules of troubleshooting

Because troubleshooting is a logical process, it makes sense to consistently follow a set of guidelines to insure both safety and efficiency of the process. Here's the set of guidelines I follow:

1. Safety first — know the hazards associated with the equipment you are troubleshooting. Take all safety precautions. Expect the unexpected. Take your time.

2. Always think "what if?" This applies both to the analytic procedures as well as to precautions with respect to probing the equipment. When probing, insulate all but the last 1/8" of the probe tip to prevent costly shorts. (If I had a nickel for every time I have caused myself problems not following this advice. . .)

3. Learn from your mistakes. We all make mistakes. Some of them can be quite costly. A simple problem can turn into an expensive one due to a slip of the probe or being over eager to try something before thinking it through. While stating that your experience in these endeavors is measured by the number of scars you have may be stretching the point, expect to make mistakes — we all can point to that disaster due to inexperience or carelessness. Just make it a point not to make the same mistake again.

4. Don't start right in with the electronic test equipment, start with some analytical thinking. Many problems associated with consumer electronics equipment do not require a schematic diagram (though one may be useful). Most problems with VCRs, CD players, tape decks, and answering machines, are mechanical and can be dealt with using nothing more than a good set of precision hand tools; some alcohol, degreaser, contact cleaner, light oil and grease; and your powers of observation (and a little experience). Your built in senses and that stuff between your ears represents the most important test equipment you have.

5. If you get stuck, sleep on it. Sometimes, just letting the problem bounce around in your head will lead to a different, more successful approach or solution. Don't work when you are really tired — it is both dangerous and mostly non-productive (or possibly destructive).

6. Many problems have simple solutions. Don't immediately assume that your problem is some combination of esoteric

complex convoluted failures. For a TV, it may just be a bad connection or failed diode. For a VCR, it may just be a bad belt or idler tire — or an experiment in rock placement by the owner's 3-year old. For a CD player, the cause of a malfunction may simply be a dirty lens or need for lubrication.

Try to remember that the problems with the most catastrophic impact on operation, a dead TV or a VCR that eats tapes, usually have the simplest solutions. The kind of problems we would like to avoid at all costs are the ones that are intermittent or difficult to reproduce: subtle color noise, the occasional interference, or the dreaded horizontal output transistor blowing out every 3 months syndrome.

7. Whenever possible, try to substitute a working unit. With modular systems like component stereos and computers, narrowing down a problem to a single unit should be the first priority. This is usually safe to do in such cases and will quickly identify which unit needs work. This same principle applies at the electronic or mechanical parts level.

Note that there is the possibility of damaging the known good part by putting it into a non-working device or vice versa. This risk is most likely with the power circuitry in amplifiers, TVs and monitors, power supplies, etc. With appropriate precautions (like placing a light bulb in series with the power line to limit the current), the risk can be minimized.

8. Don't blindly trust your instruments. If you get readings that don't make sense, you may be using your equipment in a way that is confusing it. As examples, DMMs are not good at checking semiconductors in-circuit, or the power transistor you are testing may have a built in damper diode and/or base resistor. Your scope may be picking up interference which is swamping the low level signal you are searching for (TVs and monitors, or low level circuits in VCRs and CD players). Your frequency counter may be double triggering due to noise or imperfect signal shape.

9. Realize that coincidences do happen but are relatively rare. Usually, there is a common cause. For example, if a TV has no vertical deflection and no picture, it is much more likely that a common power supply output has failed than for parts in both the deflection and video subsystems to be bad. In other words, first look for a common root cause rather than trying to locate bad parts in separate circuits.

Exceptions include damage caused by lightning, power surges, dropping of the product, water, or incompetence or carelessness of the previous repair person.

Another possible cause of multiple failures is the case in which multiple electrolytic capacitors in older equipment may be deteriorating, resulting in failures of unrelated circuits. Determine if all the problems you are troubleshooting have just appeared. It is very common to be given a device to repair which

has now died totally, but prior to this exhibited some behavior that you consider marginal but that was not noticed by the owner.

10. Confirm the problem before diving into the repair. It is amazing how many complaints turn out to be impossible to reproduce or are simple cockpit error. It also makes sense to identify exactly what is and is not working so that you will know whether some fault that just appeared was actually an existing problem or one that was caused by your poking. Try to get as much information as possible about the problem from the owner. If you are the owner, try to reconstruct the exact sequence of events that led to the failure. For example, did the TV just not work when turned on or were there some preliminary symptoms like a jittery or squished picture prior to total failure? Did the problem come and go before finally staying bad for good?

11. Get used to the idea of working without service literature in some cases. While service information for TVs is nearly always available in the form of Sams Photofacts, this is hardly ever true of other types of equipment. Sams VCRfacts, for example, exist for less than 10 percent of VCR models and only the older ones include anything beyond (obvious) mechanical information.

While a service manual may be available from the manufacturer of your equipment or another Sams-like source, it may not include the information you really need. Furthermore, there may be no way to justify the cost for a one time repair. With a basic understanding of how the equipment works, many problems can be dealt with without a schematic. Not every one, but quite a few.

12. Whenever working on precision equipment, make copious notes and diagrams. You will be eternally grateful when the time comes to reassemble the unit. Most connectors are keyed against incorrect insertion or interchange of cables, but not always. Apparently, identical screws may be of differing lengths or have slightly different thread types. Little parts may fit in more than one place or orientation. Etc. Etc.

13. Pill bottles, film canisters, and plastic ice cube trays come in handy for sorting and storing screws and other small parts after disassembly. This is particularly true if you have repairs on multiple pieces of equipment under way simultaneously.

14. Select a work area which is wide open, well lighted, and where dropped parts can be located — not on a deep pile shag rug. The best location will also be relatively dust free and allow you to suspend your troubleshooting to eat or sleep or think without having to pile everything into a cardboard box for storage.

15. Understand the risk of ESD — Electrostatic Discharge. Some components (like ICs) in solid state electronic devices are vulnerable to ESD. There is no need to go overboard but taking reasonable precautions such as getting into the habit of touching a *safe* ground point first.

Warning: Even with an isolation transformer, a live chassis should *not* be considered a safe ground point. This applies mostly to TVs, computer and video monitors, some ac operated strobe lights, and other line connected devices. You shouldn't be touching components with the device powered and plugged in (at least, not until you really know what you are doing). Once the unit is unplugged, sheet metal shields or other ground points should be safe and effective.

Some quick tips or rules of thumb

After a technician gains a certain amount of experience, he learns that there are certain symptoms that generally are

caused by specific conditions. Here are some things I have learned along the way.

- Problems that are erratic or intermittent, that come and go suddenly, are almost always due to bad connections: cold solder joints or internal or external connectors that need to be cleaned and resealed. It is amazing what a large percentage of common problems fall into the category.

When dealing with intermittents, pay particular attention to areas of the circuit board where there are large and/or high power components, connectors, or evidence of discoloration or actual charring due to excessive heat. Your eyeballs, a bright light, and magnifier will be the most useful test equipment for this purpose.

- Problems that change gradually, usually they decrease or disappear as the equipment warms up, are often due to dried up electrolytic capacitors.

While capacitors will occasionally leak, making diagnosis easy, in most cases there are no obvious signs of failure. (Note: Don't be misled into thinking that the adhesive often used to anchor large capacitors and other components to the circuit board is leakage.) The most useful testing device for electrolytic capacitors is an ESR meter.

- Problems that result in a totally dead unit or that affect multiple functions are generally power supply related. These are usually easy to fix.

Common failure items are the large hybrid power regulator ICs used in many VCRs and TVs, diodes and transistors, and, remarkably, high value resistors that open up.

- Catastrophic failures often result in burnt, scorched, cracked, exploded, or melted components, or similar catastrophic consequences. However, some components run hot by design and slight discoloration on the circuit board in their vicinity, while not desirable, may be normal.

Use your senses of sight and smell for the preliminary search for such evidence.

- Listen for signs of arcing or corona: snapping or sizzling sounds. A component on the brink of failing due to overheating may provide similar audible clues.

Some discharge sounds are normal for a TV or monitor when powered on or off and occasional sounds of thermal expansion are nothing to worry about. The flyback, yoke, or other (usually) magnetic component may also emit a buzz or whine constantly or intermittently without any other symptoms or implication of impending doom. However, repeated loud snaps or sizzling sounds accompanied by the smell of ozone should be dealt with immediately since they can lead to more serious and expensive consequences.

- Most VCR problems are mechanical in nature. Worn or deteriorated rubber parts, gummed up lubrication, or abuse (bad tapes or toy or peanut butter and jelly sandwich storage).

For any problem but a totally dead VCR, a check should be made for dirty or worn mechanical parts before even thinking about electronic problems or trying to locate a schematic; especially if the unit hasn't been cleaned in a few years.

- Many CD player problems are mechanical: dirty lens, worn or oily drawer belts, dirt/gummed up grease on sled tracks/gears, bad/partially shorted spindle, or sled motor. Power problems with portables seem to be common as well. No matter what the symptoms, always make it a habit to clean the lens first; many

peculiar failure modes are simply due to a dirty lens. Actual laser failure is relatively uncommon. CD players are also remarkably robust. Optical alignment should never be needed under normal conditions of operation.

- TV and monitor problems are very often power supply or deflection related. These problems tend to have obvious causes: blown posistor, rectifier diodes, filter capacitor, HOT, or chopper. Flyback with shorted windings or shorts between windings or in the voltage multiplier (if used) or screen/focus divider network are also common. Where the HOT or chopper is involved, operation should be observed after the repair, as components in the vicinity may cause the new parts to fail. HOTs should generally not run hot. If they do, check for weak drive, excess B+, etc.

- Microwave oven problems are almost always power related. Faulty components in the microwave generator (magnetron), HV diode, HV capacitor, and HV transformer, are relatively easy to identify. Sometimes, components on the primary side can cause baffling symptoms like the misaligned interlock switches that blow fuses or the weak triac that causes the oven to blow the main fuse only when the cycle ends. Control problems may be due to a spill in the touchpad, dried up electrolytic capacitors in the low voltage power supply, or failure confused state due to a power surge.

- Ink-jet printers are extremely reliable electrically. Look for simple problems such as caked ink in the "service station" area, misaligned print-head contacts, or a nearly empty cartridge when erratic printing problems develop.

- Laser printers tend to develop problems in the fuser, scanner, or power control modules. These are often simple like a burned out lamp, bad motor, or bad connections.

- Turntables or record changer problems are very likely to be due to gummed up grease.

- Problems with audio tape decks like VCRs are mostly mechanical. Similar solutions apply. Where one channel is out, suspect a broken wire at the tape head before blaming a bad chip.

- Telephone line connected equipment like modems and phones are susceptible to phone-line surges. Where a device seems to respond to user commands but does not dial or pick-up, suspect a blown part near the phone line connector.

- Use a moistened finger to probe *low voltage circuits*. This has come to the rescue many times. Touching various parts of a circuit from the solder side of the board in an attempt to evoke some sort of response can work wonders. Once a suspect area has been identified, use a metal probe or nail to narrow it down to a specific pin.

The reason this works is that the reduced resistance of your moist skin and your body capacitance will change the signal shape and/or introduce some slight signal of its own.

- Logic circuits — marginal timing or signal levels will change dramatically in behavior with a slight "body" load. It has been possible to locate a race condition or glitchy signal on a 305 pin PGA chip using this approach in less time than it would have taken to roll the logic analyzer over to the system under test. Signals which have proper levels and timing are generally remarkably immune to this sort of torture.

- Analog circuits — behavior can again be altered. In the case of audio amps, probing with a finger is just as effective

as the use of a signal injector, which is what you are doing, — and the equipment is always handy. By evoking hum, buzz, clicks, and pops, locating the live or dead parts of a circuit is rapid and effective.

- Unknown circuits — where no schematics are available, it may be possible to get the device to do something or locate an area that is sensitive to probing. The function of a section of circuitry can often be identified by observing the effects of touching the components in that area.

For example, I was able to quickly identify the trigger transistor in a wireless door bell by using my finger to locate the point that caused the chimes to sound. This quickly confirmed that the problem was in the RF front end or decoder and not the audio circuitry.

- Bad bypass capacitors — touching the power/signal side of a good bypass cap should result in little or no effect. However, a cap with high ESR and/or reduced capacitance will not be doing its job bypassing the pickup from your finger to ground: when you touch it, there will be a dramatic effect in audio or video systems.

If you try this technique, don't get carried away. Too much moisture may have unforeseen consequences.

Depending on the condition of your skin, a tingle may be felt even on low voltage circuits under the right conditions. However, this is pretty safe for most battery-operated devices, TTL/CMOS logic, audio equipment (not high power amps), CD players, VCRs (not switching power supply), etc.

Warning: Make sure you do this only with *low voltage* circuitry. You can easily fry yourself if you attempt to troubleshoot your TV, computer monitor, photoflash, or microwave oven in this manner!

On-line tech-tips databases

A number of organizations have compiled databases covering thousands of common problems with VCRs, TVs, computer monitors, and other electronic equipment. Most charge for their information but a few, accessible via the Internet, are either free or have a minimal monthly or per-case fee. In other cases, a limited but still useful subset of the for-fee database is freely available.

A tech-tips database is a collection of problems and solutions accumulated by the organization providing the information or other sources based on actual repair experiences and case histories. Since the identical failures often occur at some point in a large percentage of a given model or product line, checking out a tech-tips database may quickly identify your problem and solution.

In that case, you can greatly simplify your troubleshooting or at least confirm a diagnosis before ordering parts. My only reservation with respect to tech-tips databases in general, this has nothing to do with any one in particular, is that symptoms can sometimes be deceiving and a solution that works in one instance may not apply to your specific problem. Therefore, an understanding of the hows and whys of the equipment, along with some good old-fashioned testing, is highly desirable to minimize the risk of replacing parts that turn out not to be bad.

The other disadvantage — at least from one point of view — is that you do not learn much by just following a procedure

developed by others. There is no explanation of how the original diagnosis was determined or what may have caused the failure in the first place. Nor is there likely to be any list of other components that may have been affected by overstress and may fail in the future. Replacing Q701 and C725 may get your equipment going again, but this will not help you to repair a different model in the future.

One alternative to tech-tips databases is to search at Deja.com (http://www.deja.com/home_ps.shtml—formerly Deja-News) for postings with keywords matching your model and problem and the newsgroup sci.electronics.repair.

Having said that, here are some tech-tips sites for computer monitors, TVs, and VCRs. You may find that some of these websites may have moved or closed down, but because websites sometimes come and go erratically, we include them all for your information.

- Anatekcorp Tech Forum (Free) <http://www.anatekcorp.com/techforum.htm>
- Repair World (\$8/month) <http://www.repairworld.com/>
- Electronic Repair Tips Home Page (Free, somewhat limited) <http://elmswood.guernsey.net/>
- Electronics Info (free large text files) <http://ramiga.rnet.cgl.com/electronics/info.html>
- Golden Rule Electronics (Free, limited) <http://members.aol.com/rodzskolar/>

Here is one for TVs, VCRs, camcorders, and audio. There is also some specific information on RCA EEPROM contents and Sony service tips. It includes a technical forum (discussion group) and is currently free but is not as comprehensive as some of the others:

- Technician's Desk Reference <http://www.1stchoiceav.com/toc.htm>

Here is a site from which you should be able to download a fully operational version of a database with over 115,000 tips for TVs, VCRs, camcorders monitors, microwave ovens, audio equipment, and more. It will work for 14 days and can be purchased and registered during this time. There are versions for both Windows (WinSTIPS) and DOS (SVCTIPS).

- WinSTIPS and SVCTIPS Page <http://www.servicesoftware.com/prod01.htm>

They also offer ServiceTalk (<http://www.servicesoftware.com/prod01.htm>), an on-line discussion group for electronics repair professionals. This members-only forum has access to a subset of WinSTIPS (about 17,000 tips).

Here are a couple of comprehensive tech-tips databases just for VCRs that are currently free:

- Fixer — VCR Repair Instruction (Quite extensive) <http://www.fixer.com/dbase/>
- Vidcam (Australia, but has USA models as well) <http://www.vidcam.com.au/faults/>

These have quite a bit of info for TVs:

- Dogcatcher's Tech Tip Site http://home.inreach.com/ba501/Tech_Tip_Page.htm
- TV Technical Assistance <http://wa6ati.webjump.com/>

The following are just for monitors. Some may be free but others require a relatively small charge (up to \$25). However,

this may include a personal reply from a technician experienced with your monitor so it could be well worth it:

- B. Collins Monitor Repair Tips <http://www.netis.com/members/bcollins/monitor.htm>
- KMR Technical Services Tech Support (\$19.95 charge) <http://www.kmrtech.com/>
- ADCC (Tech-tips of the month and 'ask a wizard' options) <http://members.tripod.com/~ADCC/tips.htm>

- Monitor Repair Info-Center (Not much here right now)

The Resolve Monitor Tech-Tips database is a diskette that is priced on the expensive side. However, a reduced shareware version may be downloaded from a number of web sites. Go to <http://www.filez.com/> and look for [resl6sw.zip](#).

The following is specifically for microwave ovens. In addition to a large database of specific repairs, there is a great deal of useful information and links to other sites:

- MicroTech Home Page (Everything you always wanted to know about microwave ovens) <http://www.gallawa.com/microtech/>.

These types of sites seem to come and go, so it is worth checking them out from time-to-time even if you don't have a pressing need. If possible, download and archive any useful information for use on a rainy day in the future. Some also include many useful links in addition to the tech-tips info so they are worth checking out even if you don't have a specific symptom to deal with.

Getting inside consumer electronic equipment

Manufacturers seem to take great pride in being mysterious as to how to open their equipment. This is not always the case, but is too common to just be a coincidence. Opening the equipment non-destructively may be the most difficult and challenging part of many repairs!

A variety of techniques are used to secure the covers on consumer electronic equipment:

1. Screws. Yes, many still use this somewhat antiquated technique. Sometimes, there are even embossed arrows on the case indicating which screws need to be removed to get at the guts. In addition to obvious screw holes, there may be some that are only accessible when a battery or cassette compartment is opened or a trim panel is popped off.

Screws will often be of the Philips variety. (Strictly speaking, many of these are not actual Philips head screws but a slight variation. Nonetheless, a Philips screwdriver of suitable size will work on them.) A precision jeweler's screwdriver set, including miniature Philips head drivers, is a must for repair of miniature portable devices.

Sometimes, you will find Torx or a variety of security-type fasteners. Suitable driver bits are available. Sometimes, you can improvise using regular tools. In the case of security Torx, the center post can usually be broken off with a pair of needlenose pliers allowing a normal Torx driver to be used. In a pinch, a suitable size hex wrench can substitute for a Torx driver. Many distributors carry a variety of security bits.

2. Hidden screws. These will require prying up a plug or peeling off a decorative decal. Unfastening these fasteners will make

it obvious that you were tinkering; it is virtually impossible to put a decal back in an undetectable way. Sometimes, the rubber feet can be pried out revealing screw holes. If there's a stick-on label, rub your finger over it. This may permit you to locate a hidden screw hole. Just puncture the label to access the screw as this may be less messy than attempting to peel it off.

3. Snaps. Look around the seam between the two halves. You may (if you are lucky) see points at which gently (or forcibly) pressing with a screwdriver will unlock the covers. Sometimes, just going around the seam with a butter knife will pop the cover at one location which will then reveal the locations of the other snaps.

4. Glue. Or more likely, the plastic is fused together. This is particularly common with ac adapters (wall warts). In this case, I usually carefully go around the seam with a hacksaw blade taking extreme care not to go through and damage internal components. Reassemble with plastic electrical tape.

5. It isn't designed for repair. Don't laugh. I feel we will see more and more of this in our disposable society. Some devices are totally potted in Epoxy and are throwaways. With others, the only way to open them non-destructively is from the inside.

Don't force anything unless you are sure there is no alternative — most of the time, once you determine the method of fastening, covers will come apart easily. If they get hung up, there may be an undetected screw or snap still in place.

The most annoying (to be polite) situation is when after removing the 18 screws holding the case together (losing 3 of them entirely and mangling the heads on 2 others), removing three subassemblies, and two other circuit boards, you find that the adjustment you wanted was accessible through a hole in the case just by partially peeling back a rubber hand grip. Been there, done that.

And on the still lighter side, from an IBM maintenance manual, circa 1925 (displayed in the Chicago Museum of Science & Industry):

"All parts should go together without forcing. You must remember that all the parts you are reassembling were disassembled by you. Therefore, if you can't get them together again, there must be a reason. By all means, do not use a hammer."

When reassembling the equipment, make sure to route cables and other wiring such that they will not get pinched or snagged and possibly broken or have their insulation nicked or pierced and that they will not get caught in moving parts. Replace any cable ties that were cut or removed during disassembly and add additional ones of your own if needed. Some electrical tape may sometimes come in handy to provide insulation insurance as well.

For those hard-to-open LCD panels: (From: Onat Ahmet (onat@turbine.kuee.kyoto-u.ac.jp).

The LCD display housings are usually secured by plastic catches built into the case. They still may have a couple of screws that are positioned in the most innovative places. Obvious places are sides of the display, and under stickers (rub your finger over a sticker and see if you can feel the hole for a screw). Also, try to look around the hinge connecting the LCD to the main housing. Look with the LCD closed, and also open; rotating open

the housing might hide some screws from view. Expect it to be awkward. By the way, do not forget small hatches that do not look like one.

After that, it is patience, and knowing the right place to twist the case to pop it open. Try not to use screwdrivers; they leave unsightly marks along the seam.

Also, if it is your own unit, and you break a few of the catches along the way, don't worry; you can put the housing back together with a few spots of adhesive.

Hand tools

Invest in good tools. This list of basic hand tools is a good place to start.

- Screwdrivers of all types and sizes including straight, Philips, Torx. Security bits for some video games, PS2s, etc. Notched straight blade for VCR mechanical tracking adjustment — make or buy.

- Jewelers screwdrivers — both straight and Philips. These are generally inexpensive but quality is also quite variable.

- Small socket driver set.

- Hex key wrenches or hex drivers. Miniature metric sizes for VCRs.

- Pliers — long nose, round nose, curved. Both smooth and serrated types are useful.

- Adjustable wrench (small).

- Cutters — diagonal and flush. Linesman's pliers.

- Wire strippers, fixed and adjustable. Crimp tool.

- Alignment tools (at least a standard RCA type for coils).

- Files — small set of assorted types including flat, round, square, and triangular.

- Dental picks — maybe a reason to go to the dentist? These are useful for poking and prodding in restricted areas (but you knew that).

- Locking clamps — hemostats — for securing small parts while soldering, etc.

- Magnetic pickup tool — you can never tell when you will drop something deep inside a VCR. If you keep a strong magnet stuck to your workbench, you can use it to magnetize most steel tools such as screwdrivers. Just keep anything magnetized away from the tape path and magnetic heads.

- Hand drill, electric drill, drill press — one or all. A small benchtop drill press (e.g., 8") is invaluable for many tasks. A good set of high speed bits (not the 1000 bits for \$9.95 variety). Also, miniature bits for PCB and small plastic repairs.

- Soldering and desoldering equipment.

Emergency screw removal

While a good quality selection of straight, Philips, Torx, and hex-head drivers should handle most screws found in consumer electronic equipment, a couple of other types do turn up and can really be a pain to remove intact.

It may be possible to remove such screws even if nothing in your driver assortment quite fits (short of buying the proper tool, that is. What a concept!). There is also the situation (very common) where someone (we won't say who) has pre-mangled the screw head! Here are a few approaches to try

when you are stuck at 2:00 a.m. on a Sunday morning with an uncooperative screw:

1. Select a driver type (usually Philips) and size that provides the best grip. Then apply as much pressure as is safely possible without destroying anything and attempt to turn the screw. What you want to avoid is slippage. Once the blade slips, the head will be quickly destroyed and then you are left with options (2) or (3), below. For a jeweler's type screwdriver, clamping something larger to its shaft can provide valuable additional leverage.

2. Use a hand grinder (e.g., Dremel tool) or thin file to create a slot in the screw head which one of your straight-blade screwdrivers will fit. Obviously, take care to avoid damage to adjacent parts and dam off the area to prevent grinding chips from getting over everything.

3. Grab the center and edge of the screw with a pair of sharp diagonal cutters and turn it. This, of course, also damages the screw head and if you are too forceful, will break your cutters as well.

4. Drill out the screw using a bit just large enough to sever the head from the shank of the screw. Then, use a pair of needlenose pliers to unscrew what remains. For large screws, drill only part way and then use a screw extractor like Easy-Out.

Note: Some of these screws have had some material like Lock-Tight (which looks like colored nail polish) applied to the top to prevent the screw from loosening on its own. This also prevents the blade of a screwdriver from properly seating, so removal of the Lock-Tight is essential before attempting removal.

About those other funny-headed screws

(From: Tony Duell (ard@p850ug1.demon.co.uk).)

As well as Phillips, there are Pozidriv and JIS screws.

Pozidriv screws can be recognized by the "starburst," the little lines on the head between the main slots. These are very common (certainly in Europe) in all sorts of equipment.

• There are also JIS (Japanese Industry Standard) heads. These look just like Philips, but the screwdriver is a little flatter on the end. Not surprisingly, these do turn up in Japanese products.

A Philips screwdriver won't even appear to fit a Pozidriv head. It will appear to fit a JIS head, but it will also damage it if it's at all tight. JIS screwdrivers are not easy to get, either.

It's not uncommon for all 3 types of screws to be used in the same equipment, especially if subassemblies were made by different companies. (From: Robert McPherson (rm502@bellsouth.net).)

There is a type of screwdriver called a "Reed & Prince" which fits these screws which are similar in appearance to Phillips screws.

Troubleshooting is a state of mind

A number of factors come into play during the act of troubleshooting: knowledge of the theory of operation of the product, experience in troubleshooting, service documentation available, test equipment and prowess in using it, and tools available. The more of these factors that a technician can apply to the job of troubleshooting, the more effective and efficient he will be. ■

Test Your Electronics Knowledge

by J.A. Sam Wilson

1. What do the initials TVRO stand for?
2. Can 45678 be a number in the octal system of counting?
3. Express the numeral 1 as a power of ten.
4. The maximum rate of change for an op amp for a given input step voltage is called the op amp _____.
5. A perfect square wave delivered to the vertical input terminal of an oscilloscope produces a rise time of $0.02\ \mu\text{s}$. What is the approximate bandwidth of the oscilloscope's vertical amplifier?
6. What type of counter clocks all of the flip-flops on and off at the same time?
7. You would expect to find a de-emphasis circuit in:
A. an FM transmitter
B. an FM receiver
C. Neither choice is correct
8. Two identical ferrite beads are used to replace one ferrite bead. The inductance in the circuit is changed to:
A. $L_1 + L_2 + 2M$
B. $2L$
9. A resistor used to replace a speaker for testing purposes is called a _____.
10. Which type of bridge circuit is used for measuring frequency?

(Answers on page 61)

What Do You Know About Electronics?

by J.A. "Sam" Wilson

Keeping informed about modern technology

Let's start by looking in on two very good technicians in 1930. Mr. I works in industrial electronics. He has just read an article on relay logic and he is sure he'd better read it again. He looks across the living room to his wife and says "I'm reading more and more, and understanding less and less." I wish I had gone into communications. That subject just can't get so complicated."

His brother-in-law, Mr. C, has just finished an up-to-the-minute article on the BFO. He looks across the living room to his wife and says "It seems to me that they are just trying to see how complicated they can make this subject. How much more involved can this stuff get?"

Sixty-five years later, their grandsons were asking the same questions about microcontroller systems and digital signal processing.

Studying modern technology

When you are studying a book or magazine article on some new technology, don't get so comfortable that you fall asleep. Also, treat the material as study material. Don't just read it. Think about the subject at hand.

What do you do when you come across an unfamiliar word? Do you look it up in an electronics dictionary, or do you assume that you'll "get to that later?" You need to get to that right away before you lose the author's train of thought.

Do not allow distractions to interfere with your study. (Your goldfish is staring at you. Is it trying to tell you something? Turn off the radio or TV set.)

When you are studying in a book, start by reading the table of contents. Mark (or copy) words you want to watch for and where they are located.

The introduction in a technical book (or magazine) is often very useful. It often gives a chapter-by-chapter outline or

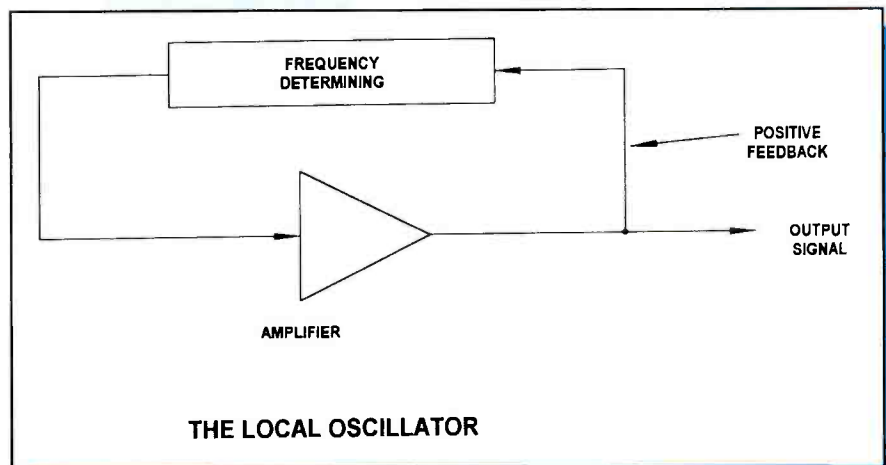

Figure 1.

page-by-page outline of where you'll be going as you study.

The English language is very difficult. I get that information all the time from foreign students in my class. Parents know that the first step in learning the English language is to learn the vocabulary. Words like Mama and Daddy are a thrill to parents. Hooking those words to the proper adult is always a great step in learning vocabulary words.

It is also a great step forward in learning technology. Make a card file with a new word on one side and its definition on the other side. Keep going through the cards until you don't need them anymore. You don't have to do that in one evening.

Here is a good example. On one side of the card, write: flash analog/digital converter. On the other side of the card, write: Flash converters operate by simultaneously comparing the input signal with unique reference levels spaced one less-significant bit apart. This information is taken from a well-written book titled "Analog to Digital Conversion" by Kevin M. Daugherty. (You will want to copy additional information on the subject of

flash converters given in the book.) Chapter 7 is devoted to flash analog/digital converters.

Memorizing

I remember the day my sister Alice came home from school crying because she had to memorize two stanzas of a poem. "You know I can't memorize poems," she said. Mom's advice: just read it over and over, and you will soon have it memorized. Her teacher gave her the same advice. I think that is actually the wrong way to memorize anything. I've been told that the secret to memorizing anything is to first understand its meaning. The reason I'm talking about this in "WDYKAE?" is that studying a new technology requires a certain amount of memorizing. Here is another example from Kevin Daugherty's book:

"The benefits of including multislopes include:

1. Increased range,
2. Increased accuracy or resolution,
3. Increased speed,"

Put this article aside right now, count to 50, then give three benefits of using

multiple slopes. If you can't do that (and most readers couldn't) you can understand why it is important to make some kind of notes as you read. It is an example of extending your memory of what you are reading. You should review your notes as often as you need to get those important concepts memorized.

Alice would find it easier to learn the poem if she would get a clear idea of what the poem is about before she learned to repeat its words.

If memory is so important for learning a new subject, it makes sense to keep a vocabulary of new technology words on file cards for reference. If you don't know the meanings of the words, you can't expect to know the meanings of sentences that contain them. I guess I'll start putting more emphasis on vocabulary in "WDYKAE?" and "TYEK."

Here is a quote that provides an example of how knowing the meaning of something aids in learning. "The time has come, the walrus said, to talk of many things. Of shoes and ships and sealing wax, and cabbages and kings. And why the sea is boiling hot, and whether pigs have wings." This verse is from "Through the Looking Glass" by Lewis Carroll.

This nonsense poem is easy to learn because you can easily form pictures of what is happening. Now try memorizing this nonsense poem (Jabberwocky) by the same author:

"Twas brillig and the slithy toves
did gyre and gimble in the wabe:
All mimsy were the borogoves
and the mome raths outgrabe."

Not so easy, is it? The words are not easily understood. You can't get a word picture in your mind.

How do you get a word picture in a technology subject? Block diagrams used in technical books are an excellent aid. Draw the block diagrams. Don't just look at them. They help to get a picture of the subject in your mind the same way your notes do. However, your block diagram should give you more detailed information than notes.

Reasoning

I found the block diagram, **Figure 1**, of an oscillator circuit, in a student's notebook. His class was building an AM radio (for soldering practice). He built his radio quickly, but it didn't work. It would have helped if his block diagram was more

accurate. Do you know what is missing from Figure 1?

He quickly determined that the oscillator was not producing an output signal. If his block diagram was complete, he could have been up and running very quickly. (He doesn't show a power supply on his block diagram — mainly because he doesn't think of the power supply as a necessary part of the oscillator circuit.)

"Check the power supply voltage," I said after watching him fumble with the radio for much too long. He argued "Aw, that won't help." Honest. The student sitting next to him heard me. He had the radio working in no time. Thinking to make a very important point in class, I asked the frustrated student: "How was the trouble located?" "Your pet student found it," was his reply. Remember this: teaching is not easy.

Learning takes time and effort

Copy block diagrams out of the book you are studying. Don't photocopy them: that won't help. Copy them by hand. Circle words in the block diagram that you have put on file cards. Read the name of the term, then check the definition on the other side. Do it until the term, and its definition, is fixed in your mind.

"But it will take a very long time for me to get through a book on a new technology," you say. Right. Now you are spending the amount of time you should be taking. If you are taking time to study it, your mind is slowed down to the amount of time required to absorb the subject. You can't speed read new technology material.

You can talk yourself out of understanding a new technology by telling yourself, or listening to others who tell you, it's too difficult to be understood. With that attitude, it is an easy matter to skip over (and never understand) those difficult parts. One help is to go to a library, preferably one in a university, and try to find another source of that material. Sometimes, it is easier to understand when it is explained by a different author. In those technical libraries, there may be a file of technical magazines that have addressed the subject in a different way.

Be sure to join your local, state, and national organizations. Other members may very well be able to help. You just can't be the only person who doesn't understand what is bothering you.

Write to technical magazines, and authors featured in those magazines. In other words, seek help from every possible source that you can. ■

ES&T Calendar

The 2000 International CES — Your Source
for Workstyle and Lifestyle Technology
January 6-9, 2000
Las Vegas Convention Center and Hotel
Las Vegas, NV

Digital Hollywood at CES
January 6-8, 2000
Las Vegas, NV

Consumer Electronics Manufacturers
Association (CEMA)
2500 Wilson Blvd.
Arlington, VA 22201-3834
703-907-7600
Website: <http://www.cemacity.org>

National All Service Convention
March 1-5, 2000
(Will include members of Electronic Technicians Association (ETA), Florida Electronics Sales and Service Association (FESA), Professional Servicers Association (PSA), and the Association of Home Appliance Service Companies (AHASC) of NJ.)
DoubleTree Conference Center and Resort
Orlando, Florida

ETA
602 N. Jackson
Greencastle, IN 46135

765-653-8262
Home Automation Convention
March 3-5, 2000
Orange County Convention Center
Orlando, FL
John Galanie 703-352-9111

ETA Annual Membership Meeting
May 5-6, 2000
ETA Headquarters
604 N. Jackson
Greencastle, IN 46135, and

The Walden Inn
Greencastle, IN
ETA: 765-653-8262

NESDA 50th/ISCET 30th/NIAS 8th Annual
National Professional Service Convention
and Professional Service Trade Show
August 7-12, 2000
John Ascuaga's Nugget Hotel
Sparks (Reno) NV

NESDA
2708 W. Berry
Fort Worth, TX 76109-2356

Test equipment showcase

A few problems in today's complex, sophisticated, consumer electronics products can be tracked down without the use of test equipment. There are the obvious ones, like a burned resistor, broken circuit trace, and the like. And with so many service tips books and computer disks, some of the more common problems can be detected and corrected. Once the technician gets beyond any of those easy problems, and into deeper technical waters, he's going to need test equipment.

When test equipment is needed, it usually works this way: the technician observes the symptoms, checks on any comments the product's owner might have made when he brought the unit in, makes a few observations of the appearance and operation of the unit, then makes a preliminary diagnosis. Once the technician has made a preliminary diagnosis, then he needs the test equipment to narrow it down. He'll need a DMM to check voltages and resistances, an oscilloscope to observe waveforms. Maybe he'll need a capacitor tester and/or an ESR meter to check out the capacitors.

The test equipment

Over the years, service centers have changed and grown to keep up with the increasing variety of consumer products, and their changed design and construction. The basic principles of electronics, however, haven't changed. This means that some of the test equipment in use by service centers today will still be useful for years to come. The DMM and the oscilloscope, and other test instruments and accessories, such as the variable transformer, the isolation transformer and the bench power supply, are just as necessary as they ever were to the serious consumer electronics technician. In other words, the arsenal of test equipment required by the technician gradually and continually grows.

But even as the requirements for newer test equipment are arising, the old standby items of test equipment are evolving and being improved.

For example, while today's technicians require oscilloscopes and test meters and other old standbys just as much as they did 10 or 20 years ago, in many cases, the

test equipment they require has to be more sophisticated than before. In other words, because the products that the technicians face are so much more sophisticated than they once were, the test equipment must also be more sophisticated.

What makes test equipment useful

A piece of test equipment is only as valuable as its usefulness in assisting the technician in tracking down the cause of a problem to the fundamental cause so he can correct the problem. The factors that make a piece of test equipment valuable include these:

- Ease of use
- Capability
- Accuracy
- Support by the manufacturer
- Versatility

Purchasing guidance is important

The more features that a product offers, the more difficult it becomes to compare features in order to know what product to buy. Anyone who has ever agonized over making a wise purchase in today's environment knows how true that is.

Fortunately, a consumer electronics service center has access to a number of resources that can help them choose from among the many test products offered by the many manufacturers. There are, for example, the catalogs offered by the test equipment manufacturers themselves. Most of these provide details of the features offered by each of the products in the company's line. Not only that, but many of the manufacturers have a treasure trove of information on how to connect the equipment, and how best to use it to achieve accurate results. Even better in some cases are the catalogs offered by distributors and by companies that rent or lease test equipment. They list products that are offered by a number of manufacturers within each price level, and so make comparison somewhat easier.

The test equipment purchase decision

When a service center buys a piece of test equipment, it would be best if the purchase was considered in detail before the purchase decision is made. Unfortunately, that doesn't always happen. For example, when it's decided that the service cen-

ter needs a new oscilloscope, the service manager may perform some research on the products and prices, and then send out a purchase order for an oscilloscope.

Most purchases done in this manner turn out fine, but sometimes the organization learns too late that the unit isn't quite what they need. For example, it may not have the required features to service some new consumer product that they will soon begin servicing. In other cases, the service center realizes that the expensive new piece of test equipment has far more features than they'll ever need, and the money tied up in it could be used elsewhere. You occasionally see some of those items listed in Readers' Exchange in this magazine.

Just as with any purchase, the use to which the test equipment will be put should be carefully studied.

The checklist

Before a service center buys a piece of test equipment, it might be useful to check the candidates against a list such as this:

- What products will this equipment be used to test (now and in the near future)?
- What bandwidth is needed?
- Single-channel, or multichannel?
- Is waveform storage needed?
- Will this be used at the bench only, or on site as well?
- Does this scope need to have on-screen readout of waveform parameters?
- Can this purchase be cost justified as a time and effort saver?

Getting to know the suppliers

Because the decision to purchase a piece of test equipment is so important, the more you know about the manufacturers or suppliers, the better informed your decision will be.

This special advertising section "Test Equipment Showcase," was conceived as a way to help bring more information about test equipment providers to readers. Every advertiser in this section has been given additional space to tell readers something about their company, or to help readers understand the value and use of that company's products.

We invite you to read what these companies that sell test equipment have to say about themselves and their products. ■

Sencore

3200 Sencore Drive

Sioux Falls, SD 57107

Phone: 1-800-736-2673

Website: www.sencore.com

For nearly 50 years, Sencore Electronics has been dedicated to one goal — making our customers more successful in electronic servicing. Today, Sencore is a leading manufacturer of electronic test equipment because we listen to our customers needs and design instruments that help them achieve success. Sencore is committed to its customers success with an exclusive product line and the absolute best support in the industry. Our obligation and support are just beginning when a customers says "yes" to Sencore equipment.

Sencore was started in 1951, in downtown Chicago, Illinois, by R.H. ("Herb") Bowden. As the business grew, Sencore moved west to Sioux Falls, South Dakota, in 1971, attracted by the area's superb quality of life. The now second generation business remains in Sioux Falls where Sencore is proud to be actively involved in community events and charities. Sencore's second generation, represented by co-owners Al and brother Doug Bowden, is committed to adapting to the technical challenges necessary to take Sencore into the 21st century.

Sencore's highly trained employees contin-

ually design new equipment based on advances in the electronics industry. With each new product, the company deals with complex issues of marketability, design feasibility, and manufacturability, and brings these together in the shortest time possible. Sencore designs and manufactures test instruments that provide the highest quality and reliability in the entire service industry.

Every Sencore instrument is engineered to provide our customers with exclusive tests and capabilities that will make testing and troubleshooting easier and more efficient. When customers invest in Sencore instruments, they also receive the best after-the-sale support available in the industry. During the past 48 plus years, Sencore has remained dedicated to one goal — making our customers more successful. And since our success depends on our customers success, we're working even harder to be the premier test equipment company in the industry.

The future looks exciting at Sencore. As technology advances from the broadcast studio to your living room TV receiver, Sencore is preparing itself for new challenges and forming global alliances to stay on top of the industry. We're a

forward looking engineering/manufacturing/marketing firm with an eye on the future.

With the ushering in of Digital Television, Sencore is proud of our alliance with Adherent Technologies in servicing North America with MPEG, DTV, and other excellent digital products. These offerings are providing cutting edge answers for the broadcasting industry in this exciting technical revolution. On November 1, 1999, the top 10 television networks went digital with the use of Sencore technology! For the past five years, Sencore has been instrumental in educating and providing the right tools to the manufacturers and broadcasters responsible for compressing video signals. They rely on Sencore to be their "digital" resource for all the changes and regulations they need to meet. Sencore provides digital solutions that support: Studios, Networks, Local TV Stations, Cable Companies, Retailers, Consumers, and ultimately Servicers!

Who knows where the future will take us next. We do know one thing. Sencore will be at the forefront of new technology with products and alliances to insure we remain on top of our industry.

See you in the future!

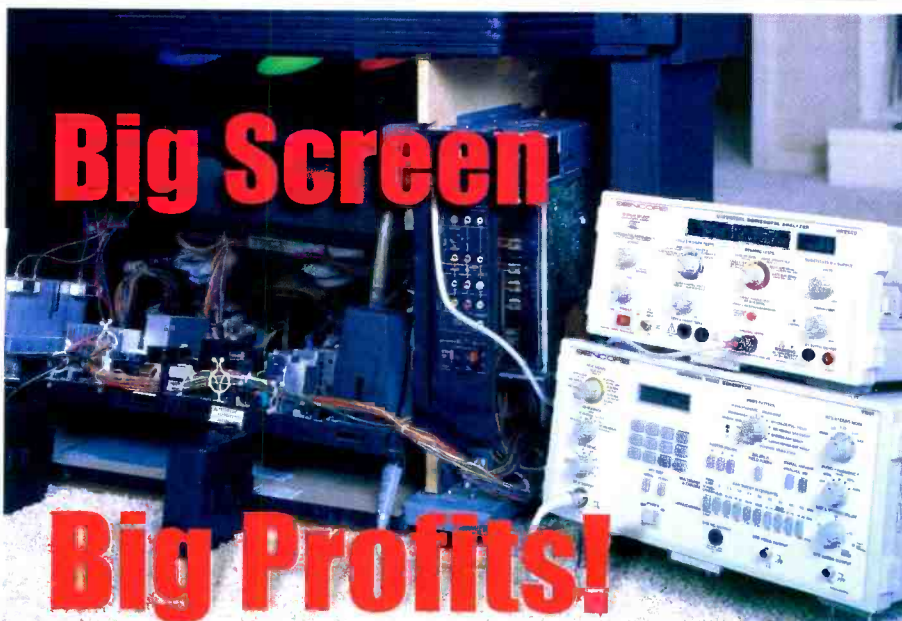

Big Screen

Big Profits!

Bring home the cash with in-home servicing of high-end electronics. Quickly and accurately aligning big-ticket items like projection TVs for your customer's total viewing satisfaction can be your best opportunity for profitability. Sencore offers servicing solutions for progressive servicers with portable, durable and reliable test equipment that brings the "best of the bench" to every home.

SENCORE
1-800-SENCORE

www.sencore.com • email: sales@sencore.com

HA2500 Universal Horizontal Analyzer

Localize horizontal and B+ Supply defects in less time and more profitably than ever before!

- Exclusive "Horizontal Output Load Test" makes setup and testing a snap - even without applying AC power for faster diagnosis
- Patented "ringer" proves the condition of flybacks and yokes in seconds
- Exclusive "dynamic tests" help you analyze the horizontal circuit in powered-up conditions

VG91 Universal Video Generator

This complete all channel RF/IF/MTS Universal Video Generator performance tests and isolates defects in any NTSC video system, including big screen TV systems!

- Proof-positive tests for MTS Stereo/SAP on all channels
- Exclusive and dynamic NTSC video test signals
- Standard, Y/C, composite video, and audio line outputs

Circle (7) on Reply Card

Pomona Electronics

1500 E. Ninth Street

Pomona, CA 91766

Phone: 909-623-3463

Fax: 909-629-3317

www.pomonaelectronics.com

www.pomonaelectronics.com
— Click to “Find A Pomona
Distributor Near You”

Now it's easier than ever for you to find a Pomona distributor in your area. The Pomona website, www.pomonaelectronics.com, has been expanded to include a new search feature that provides a fast, convenient way to locate the nearest Pomona distributor anywhere in the world. From the Home Page, select “Where to Buy Pomona Products.” The next screen allows you to choose between Canadian, international and U.S. distributors. If you select from U.S. distributors, you are then provided the option of selecting a national distributor and connecting immediately via hyperlink, or accessing a convenient pull-down menu to select a local distributor location by state.

Users have been very enthusiastic about our first search feature, a technical data base that allows you to locate product data sheets either by Pomona model number or by descriptive keywords. In

many cases, the ability to view or download on-line technical data sheets has helped you make an immediate product selection decision. Now, with the expanded site capability of the “distributor search” function, you can take the next logical step and select a distributor while still on the site and jump to that distributor's site to place the order.

The Pomona site puts you directly in touch with the entire line of Pomona Electronics test and measurement accessories. Since you may already have a specific application in mind, access to the Pomona site will allow you to choose the appropriate accessories for your job immediately. Once you've made your product selection decision, it's only a click to a distributor site to order the product.

Plans for the further expansion of the Pomona site are already in place. The next phase will include an option to display photo images so that you can see the product of your choice before selecting a data sheet for viewing or downloading. By year's end, the site will feature Pomona's full-line product catalog. “We want to con-



tinuously update and improve our website so that it is an increasingly valuable tool,” said Sharon Ead-Muise, Marketing Manager. “It is an on-going process that will adapt as technology and market trends demand. If you have not yet visited our site, we encourage you to do so soon, and let us know what you think.” ■

Precision Electronic Probe Offers Probing Solution for High Density IC Leads

Pomona Electronics introduces the Precision Electronic Probe for probing extremely fine pitch IC leads including TSSOP and SSOP packages. Ergonomically designed to fit your hand, the new probe offers a subminiature tip of only .018” in diameter, a fraction of the size of conventional probe tips.

The Model 6342 Precision Electronic Probe provides accuracy and accessibility for testing difficult-to-reach areas of surface mount and densely populated circuit boards in repair and test lab applications. Although small in outline, the slim design enables a firm grip and access into tight spots without obstructing visual contact within the test point area. The probe's thermoplastic elastomer outer layer provides a comfortable and secure grip, and the Precision Electronic Probe tip can be easily replaced if damaged. Many different probe tips are available for nearly any probing situation.



“This test probe fits into places other probes can't,” said Robert Poirier, Product Manager at Pomona Electronics. “And, replacement tips are readily accessible, typically from the customer's own off-the-shelf stock. Companies with automated test equipment use the same pogo type pins as the 6342 Probe, and usually stock them, providing a convenient means of tip replacement, without tools.”

Pomona Electronics offers a wide range of probe tips in a variety of styles, including the spring-loaded plunger tip, which allows the tip to “float” while maintaining a constant level of pressure, assuring steady, reliable contact. This “pogo-pin” feature prevents the tip from slipping and damaging other components or circuit board traces. Stainless steel tips for penetrating surface contamination, multi-head tips, and extra long probe tips are also available.

The Precision Electronic Probe design is fully compliant with the latest international safety standard, IEC 1010 with Category III, 1,000 volt overvoltage protection. It has a maximum current rating of 3 Amps. The probe is also available in specialty test lead kits designed for specific applications, and can be used with digital multimeters from any of the major manufacturers.

Technical and product information is available 24 hours a day on-line at www.pomonaelectronics.com. Pomona Electronics is located at 1500 E. Ninth Street, Pomona, CA 91766-3835, Tel: (909)623-3463. ■

Plug anything but Pomona into me,
and you'll get a signal you'll never forget.



Circle (116) on Reply Card

Pomona[®]

Your Instruments Know. Some have called the portable DMM the test engineer's best friend. But feed it shaky input signals from a bad set of test leads, and its performance can suddenly turn on you. Of course, you can avoid such altercations by using Pomona test accessories. No matter what you're testing—from high density ICs to high speed motor drives—Pomona makes the connection secure. Plus, superb grip designs and ergonomics give you maximum flexibility and comfort. And Pomona also offers turnkey test kits for all leading DMMs—to completely satisfy their need to make fast, reliable measurements. So stick with the accessories preferred by savvy DMMs the world over. Contact Pomona Electronics at Tel: (909) 469-2900, Fax: (909) 629-3317. www.pomonaelectronics.com. And just tell them your instrument sent you.

B&K Precision

1031 Segovia Circle

Placentia, CA 92870

Phone: 714-237-9220

Fax: 714-237-9214

Website: www.bkprecision.com

For over 50 years, B&K Precision Corporation has developed a reputation for excellent in the design and manufacture of high-quality, reliable, and cost-effective test and measurement products. The company's products are used in a wide range of applications including engineering, research and development, production line testing, industrial maintenance and repair, electronic field service and education.

B&K Precision — the only U.S. manufacturer with a complete selection of general instrumentation products from AC and DC power supplies to a quality line of hand-held and bench-top multimeters at the most competitive price points in the

market. Other products include high performance spectrum analyzers, function and signal generators, oscilloscopes and EPROM programmers, cable probes and testers, multifunction counters, and a full line of accessories.

B&K Precision is committed to continuing the support of their core distribution business with excellent price/performance test equipment, but they are also actively developing new, more sophisticated products to meet the changing demands for test instrumentation. These new products will enable the company to offer a wider range of test products over a broader market segment than ever before. With the on-going expansion of

the product line, the company is poised to be one of the leading suppliers of multimeters, function generators, oscilloscopes, power supplies, device programmers, counters, and test accessories in the world.

Recognized for their price-performance value, ease of use, measurement accuracy and application flexibility, B&K Precision Corporation products are available worldwide through a global network of authorized distributors. For further information, contact B&K Precision Corporation, 1031 Segovia Circle, Placentia, CA 92870, (714) 237-9220, Fax: (714) 237-9214, Web site: WWW.bkprecision.com

50 Years old and still **HOT!**

INNOVATION

PERFORMANCE

VALUE

Like premium red wines, we only get better with age. For the past 50 years, we have served the electronics industry by providing innovative products that were built to last - at affordable prices. Hundreds of thousands of engineers and technicians use our products on a daily basis. They keep coming back for more, for all the right reasons: innovation, performance & value. Check out our Fall '99 offering of new products. Ask for a catalog or check them out on the web.

IC Tester



Tests hot chips like TTL, CMOS, & LSI.

EPROM Programmer



Programs those chips for HDTV, CDMA or GSM.

Mini-Pro DMM



Innovative, packed with features at budget prices. Includes a unique non-contact voltage indicator.

Programmable Power Supply



User friendly programming, RS-232 interface.

Arb Generator



Creates waves by point like nobody else.

BK PRECISION®

SETTING NEW STANDARDS IN PERFORMANCE & VALUE

1031 Segovia Circle, Placentia, CA 92870

(714) 237-9220 Fax: (714) 237-9214

www.bkprecision.com

Circle (62) on Reply Card

Electronic Design Specialists

4647 Appalachian Street

Boca Raton, FL 33438

Phone: 561-487-6103

Website: www.eds-inc.com

Electronic Design Specialists makes test equipment designed to help servicing electronic technicians troubleshoot problems as quickly and accurately as possible. All test equipment is designed by David T. Miga, CET, who is both an electronic engineer and a certified electronic technician.

The EDS Corporation was started in 1986 when Dave designed a digital capacitor meter and a semiconductor analyzer to increase his own productivity as a contract technician. When other technicians saw what the EDS-52 capacitor meter and the EDS-59 semiconductor analyzer could do, Dave found himself being asked to build more of these prototypes for them. The production version of the semiconductor analyzer, the SemiAnalyzer 59C, was very successful and was sold from 1987 until 1997. Other unique test equipment followed, such as the Bus Line Tracer, the MicroAnalyzer, the LeakSeeker, and the very popular CapAnalyzer. Although designed for independent service technicians, regular users are the U.S. military, most of the Fortune 500 companies, NASA, the TV networks and cable companies, Panasonic, Pioneer and many trade schools and colleges.

Dave designs his test equipment with an entirely different perspective than most test equipment companies. All ideas start with interviewing thousands of independent service technicians for their opinion and special needs. This approach is different from conventional test equipment manufacturers, where equipment is designed by engineers that may have never picked up a soldering iron, who wouldn't be able to repair their own television, even with their own test instruments. Their idea for test equipment is to bombard the technician with numbers, to be expensive and to be difficult to use. This is overkill for a servicing technician; check out the "used test equipment" section in the classifieds of this magazine for these products.

For this reason, all EDS equipment is designed to give the technician the tools to tell whether a component is good, poor, or bad, in circuit, as accurately as possible. A technician doesn't need to know what a capacitor's dissipation factor or dielectric constant is; just is it bad, can I move on? EDS test equipment is designed by technicians for technicians, is guaranteed accurate for in-circuit tests, and is designed for easy use. Determining the quali-

ty of a component in question is done by the test instrument, not the technician.

To design a test instrument to decide whether a component is good or bad, EDS analyzes actual defective components sent in by technicians. Calibrating the test equipment is done by comparing new, old but still working, and known defective components, then programming the test equipment to make the decision, with Dave's 30-year experience as helpful input. Every CapAnalyzer 88A is still tested with the same actual good, poor, and bad electrolytics and tantalums used to design the original prototype, before releasing it to the customer.

EDS was the first on the World Wide Web with animated demonstrations of test equipment products, and has one of the best technical assistance programs on the Internet. You can even download replacement owner's manuals and review tech tips, and get self-maintenance help for each product.

As the electronic service repair industry moves into the twenty-first century, more and more technicians will discover that to be productive, less time must be spent looking at schematics of increasingly complicated circuits. Simply checking components in the circuit with the problem, with the right test instruments, is how profitable repairs will be done by the surviving technicians of the next millennium.

EDS products are available from your distributor. For international sales contact EDS directly. Check out www.eds-inc.com for a current list of distributors. All products come with a 60-day satisfaction guarantee or money-back policy.

BOB SAVED THE WORLD TODAY...



Bob, Super-Tech extrodinaire, has a secret weapon. This amazing device allowed him to locate and replace all 34 bad electrolytic capacitors in this TV in less than 30 minutes. So instead of throwing this TV into the local landfill and adding more pollution, Bob's secret weapon enabled him to give the World a brighter future. Impressed his manager and his customer too. Bob's secret weapon? The world's best in-circuit cap checker, the *CapAnalyzer 88A* by EDS.

Smart techs know that to be productive you need to find defective components quickly and accurately.

That's why General Motors, Matsushita Industrial, Sears Service, Pioneer Electronics, Panasonic Authorized Service, NASA/Kennedy Space Center, Time/Warner Communications, NBC TV and thousands more independent service technicians have chosen the *CapAnalyzer 88A* over all of the other capacitor checkers. Check www.eds-inc.com/88users.html for actual *CapAnalyzer* users' comments as they compare their *CapAnalyzer* to the "wizards" and "z-meters" they already own. They all prefer the *CapAnalyzer* because it checks electrolytic capacitors, *in-circuit*, with 100% accuracy. No unsoldering to check out-of-circuit, no mistaking a shorted or leaky cap as good, as other "ESR" meters do, no guessing about whether a value is good or bad. With our exclusive three-color comparison chart right on the front panel, auto-discharge, multi-beep alert, and one-handed tweezer test probe, even your pet monkey could find defective caps in that problem PWM power supply, TV, monitor or VCR in a few seconds.

...NOW IT'S YOUR TURN.

So get your own *CapAnalyzer 88A*. It's only \$179. With our exclusive 60-day satisfaction-or-money-back guarantee, you risk nothing. Prepare to be amazed: your only problem will be running out of work as you take care of all of those "dogs" that you've been sitting on. We're **Electronic Design Specialists**. We make test equipment designed to make you money.

Available at your distributor now, or call 561-487-6103.

Check out www.eds-inc.com for all of the details.

Howard W. Sams

2647 Waterfront Parkway East Drive

Indianapolis, IN 46214-2041

Phone: 800-428-SAMS

Fax: 800-552-3910

Over 50 years ago, Howard W. Sams was the first company to recognize that the increasing popularity of home entertainment electronics meant a corresponding demand for reliable service documentation. This insight gave birth to the first PHOTOFACT® which presented concise technical information to help service technicians repair specific makes and models of radios. Televisions were soon added to the product line, followed by computer equipment and then VCRs.

Today, Howard W. Sams is the nation's largest provider of after-market service data for televisions and VCRs in the form of PHOTOFACT® and VCRfacts® through subscription services, distributors, and direct order. Some 95% of after-market repair companies use Howard W. Sams technical data.

The recent introduction of E:fact®, a downloadable version of Sams' PHOTOFACT®, will take Sams into the 21st Century. E:fact® is available for all PHOTOFACT® from 1992 through current sets. E:fact® is only available at www.hwsams.com and sells for \$10.95. E:fact® is delivered to the customer's e-mail box, generally within 24 hours of ordering. Additional details along with a free sample of E:fact® can be found at www.hwsams.com.

Prompt® Publications is fast becoming one of the top technical imprints in the nation. Prompt® Publications is focused on technical books designed for both the novice and the experienced technician. Each Prompt® Publications book provides a clear understanding of the principles involved in the installation, maintenance, and performance of the electronic

devices that have become such a large part of our daily lives..

At www.hwsams.com, guests are treated to complete titles summaries for Prompt® books as well as downloadable chapters of select books and an entirely searchable version of the Annual Index. On-line response forms are provided to request free copies of the Annual Index and Prompt® Publications Book Catalog.

PHOTOFACT® and Prompt® Publications strive to produce appropriate, timely, and well-written technical documentation and books in a manner that develops long-term, loyal customer relationships. To receive more information on any of Howard W. Sams products or services, please call 800-428-7267 or visit www.hwsams.com.

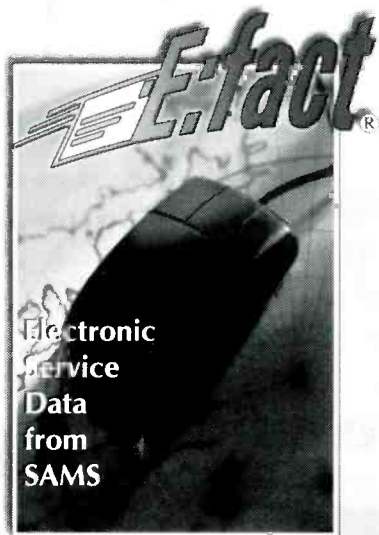

It's About Time!

- It's about saving time with each repair.
- It's about someone finally providing electronic service data that is easy to use and inexpensive.
- It's about E:fact from Howard W. Sams!

You'll have what you need in a day!*

It's about time!

*See Our Website For Important Restrictions and Requirements.

**All for only \$10.95 – Available only at www.hwsams.com
– Electronic Service Data from SAMS –**

A Bell Atlantic Company
Howard W. Sams
1.800.428.SAMS

Circle (66) on Reply Card

Products

Desoldering tips

Pace introduces a new line of desoldering tips that according to the manufacturer, virtually eliminate tip clogging and safely deliver more heat and last longer than conventional tips.

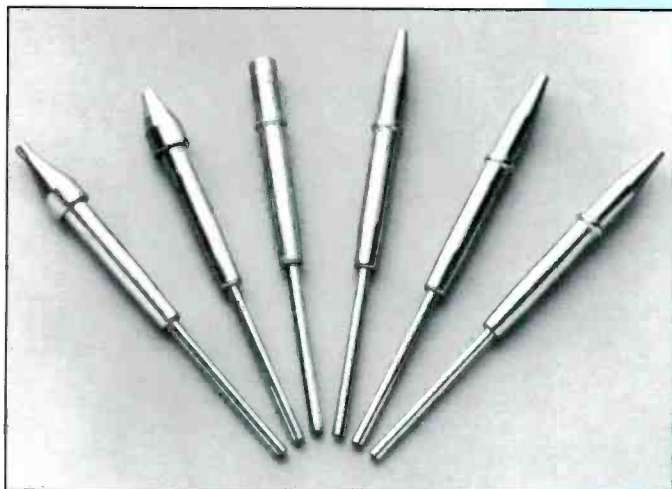

Endura desoldering tips feature a unique anti-clogging riser tube to ensure that solder is delivered to the collection chamber in the molten state, virtually eliminating clogging and allowing continuous work flow. The tips are available in three configurations: Thermo Drive tips which deliver more heat and last longer, Precision tips for desoldering the finest through-hole leads or leads in tight areas, and Precision Flo-Desoldering tips to safely remove solder from small pads and vias. Several configurations of each are available.

Pace, 9893 Brewers Court, Laurel, MD 20723-1990, Phone: 301-490-9860, Fax: 301-498-3252, Website: www.paceusa.com

Circle (80) on Reply Card

Computer monitor pattern generator

B&K Precision announces the Model 1280A Computer Monitor Pattern Generator. Designed to test both PC and MAC monitors, the unit is for use by service technicians in bench-top test or multiple monitor burn-in applications.

The generator was designed to provide a thorough evaluation of the operating condition and alignment of a computer monitor and allows internal or external adjustment for optimum performance. The unit enables the user to conduct operational and evaluation tests using crosshatch or dot patterns, color bars, window and raster patterns, in red, green, blue, black, and white.

The crosshatch or dot patterns may be used to evaluate the static and dynamic convergence, linearity, and pin cushion settings. The Color Bars are used to test the monitor's ability to produce proper colors. Raster is used to check the purity of the primary colors. Setting the Auto/Manual Switch to Auto allows the output to automatically cycle through all patterns.

Packaged in a compact 3 1/8" x 9 7/16" x 9 1/4" bench-top enclosure, the Model 1280A can be used to test CGA, EGA,



VGA, SVGA, and MAC monitors with a wide range of resolutions including 640 x 480, 800 x 600, 1064 x 768, and 1280 x 1024. The unit works with both interlaced and progressive monitors and provides color bars, crosshatch, dots, color raster, and window patterns. Additional features include single push-button selectable patterns and multiple monitor testing or burn-in. It is equipped with a variety of rear and front-panel-mounted connectors including a 9-pin D (CGA and EGA), 15-pin D (MAC), and 15-mini-pin D (VGA, SVGA, and 8514A).

Convenient front-panel controls and indicators include the Power On/Off slide switch, LED Power On Indicator, System Type Switch (selects MAC or PC), Monitor Type Selector Switch, and step-through Video Pattern Switch. Rear-panel connectors include the AC adapter jack, four DB 15 mini-pin female jacks, RGB BNC connector, and horizontal and horizontal sync outputs via a BNC connector.

B&K Precision Corporation, 1031 Segovia Circle, Placentia, CA 92870-7137, Phone: 714-237-9220, Fax: 714-237-9214, Website: www.bkprecision.com

Circle (81) on Reply Card

Video test generator

The Quantum Data 822S video test generator delivers a programmable video clock rate of up to 600MHz and up to 800MHz for testing a wide variety of today's highest resolution displays. A test technician using this device is able to match the exact timing for virtually every monitor manufacturer's version of 5, 6, 7, and 8 megapixel displays.

A flexible and configurable mainframe lets the user choose a combination of available video output modules to meet a variety of testing needs. A basic choice might contain a single video module for testing monochrome displays. A production monochrome application could use two or three video modules, one for reference display and the rest for the displays being adjusted to match the reference. Three modules are needed for color applications, one for each primary color (RGB).



This flexible unit allows a service technician to choose 600MHz now and expand to 800MHz later as resolution needs evolve, by substituting a new video module.

Quantam Data, Inc., 2111 Big Timber Road, Elgin, IL 60123, Phone: 847-888-0450, Website: <http://www.quantamdata.com>

Circle (82) on Reply Card

Oscilloscope probe adapter

Emulation Technology introduces an oscilloscope probing kit enabling designers to perform fine-pitched probing from 0.8mm to 0.3mm with any standard oscilloscope.

There are three separate oscilloscope probing adapter kits available, depending upon the lead pitch to be probed. Each kit contains parts for use with two probes, including four MicroGrippers and two Dual-lead adapters. If more probes are being used, additional kits are available.

Emulation Technology, 2344 Walsh Avenue, Building F, Santa Clara, CA 95051-1301, Phone: 1-800-ADAPTER, Fax: 408-982-0664

Circle (83) on Reply Card

Switch-mode technical training

The TT400 Hands-On switch mode power supply course from Sencore is a self-paced training course that teaches effective switch-mode power supply repair procedures. The course comes with a comprehensive 180 page, fully illustrated, full color workbook that provides theory of operation of the SMPS, how SMPS's fail, practical SMPS examples, and step-by-step procedures for troubleshooting.

The course also contains three SMPS trainers (linear, pulse rate modulated, and pulse width modulated) that provide service technicians with "hands-on" troubleshooting in a known-good supply. The trainers let the user become familiar with the voltages and waveforms in a working supply. Trouble switches on the SMPS trainers create common power supply failure modes for applying the troubleshooting procedures the user learned.

The course includes the PSL60 universal power supply load. This helps the user isolate power supply problems from system defects. It also simulates different power demands on the power supply output to duplicate the symptoms and identify problems.

Sencore, 3200 Sencore Drive, Sioux Falls, SD 57107, Phone: 1-800-Sencore

Circle (84) on Reply Card

Color sensor

The CS-1 Color Sensor from Quantum Data measures the color and light output of a monitor to enable a technician to do a white balance alignment of a color display. An RGB sensor provides interactive adjustment of the monitor under test. Measurements and adjustments are viewed on a single screen display.

The sensor can be used as a standalone testing device using any video signal source or standalone generators. The interface operates as a virtual control panel within a MS-Windows 95/98 environment.

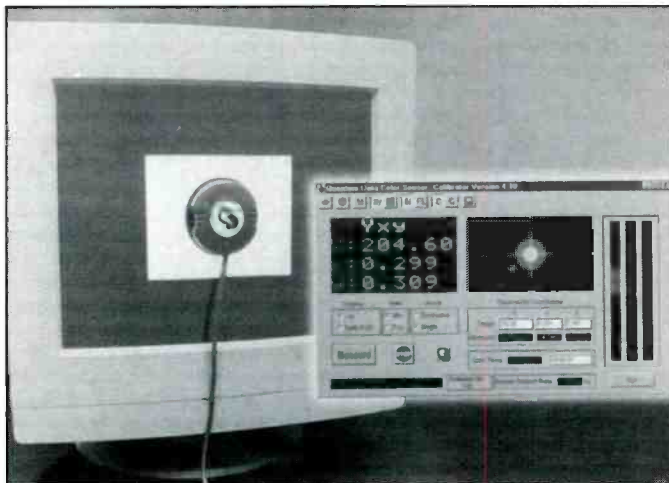

The sensor package, called a "pod," attaches to the monitor by means of an integral suction cup, and connects to a user's PC via a serial port. Color measurements may be displayed in C.I.E. Yxy chromacity values or RGB offset (Delta RGB). Color temperature is continually updated for comparison to target values and/or OEM spaces.

A new VGM (Video Generator Manager) user interface is included with the unit and makes the device's full potential available to even a relatively inexperienced operator. A version of this software is available for trial use on the company's website.

Quantam Data, 2111 Big Timber Road, Elgin, IL 60123, Phone: 847-888-0450, Fax: 847-888-2802, Website: <http://www.quantamdata.com>

Circle (85) on Reply Card

Lighted magnifier

The Magni-Focuser hands-free magnifier from Edroy is now available with an 8,000 candlepower Xenon Laser Spot beam. The light addition burns for six to seven hours on batteries.

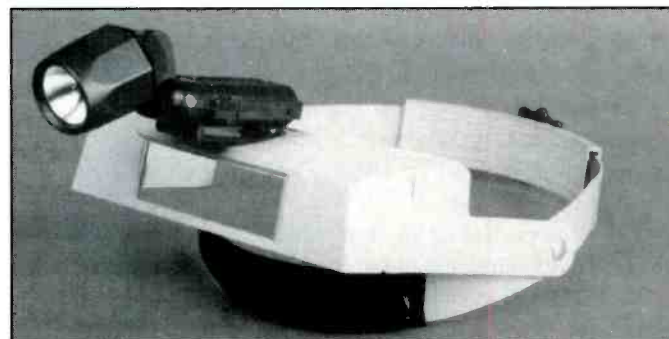

The magnifier, used by doctors, dentists, veterinarians, jewelers, industrial workers, and other professionals, features: binocular magnifier with interchangeable lens units, shatter resistant optical quality acrylic lenses, 3 1/8" by 1 1/8" lenses, no center post for unobstructed field of vision, adjustable, contoured, padded vinyl headband for a perfect fit and high impact, non-corrosive ABS plastic front lens unit that flips up when not needed and resists scratches.

The lighted unit is lightweight, comfortable, and washable and available with a bi-focal lens

Edroy Products, 245 N. Midland Avenue, Nyack, NY 10960. Phone: 914-358-6600, Fax: 914-358-4098

Circle (86) on Reply Card

IC database on the Web

Hearst Business Communications, Inc./UTP Division announces the launch of the completely redesigned IC MASTER website at <http://icmaster.com>. The new website has a faster, more powerful search engine and an easier, more efficient interface. Plus, for selected devices, there are direct "deeplinks" to actual data pages and complete application notes on the manufacturer's own website.

Now free to all engineers, IC MASTER Online speeds up the search process with a new, much requested Keyword search and a streamlined Part Number and Function search. The new site design also eliminates drilling down through information that

is not needed when looking for specific information such as second sources, application notes, or pinout and package data.

The launch coincides with publication of the 1999 IC MASTER catalog, the 25th Silver Anniversary Edition, and release of the all new 1999 IC MASTER CD-ROM for Windows. Now engineers have both the power of on-line access and the flexibility of off-line access to the integrated circuit database.

The 3-volume catalog provides access to product information on 106,000 base part numbers for current ICs from over 350 manufacturers. It includes a valuable Application Note Directory referencing over 4,000 application notes, a comprehensive Alternate Source Directory listing more than 140,000 functional equivalents, and complete vendor contact information.

The CD-ROM for Windows, also redesigned with a simpler interface and faster search engine, offers a new Quick Search by keyword or part number, an Advanced Search by function, multiple specifications, or package style, and interactive web links to data pages on the manufacturer's own website for selected devices. In addition to all the information in the printed catalog, the single CD includes discontinued ICs to deliver specifications on more than 152,000 base part numbers with pinout and package data for over 95,000 of these devices.

Hearst Business Communications, 645 Stewart Avenue, Garden City, NY 11530. Phone: 516-227-1300, Fax: 516-227-01453, Website: <http://www.hearstelectroweb.com>

Circle (87) on Reply Card

To Order Back Issues

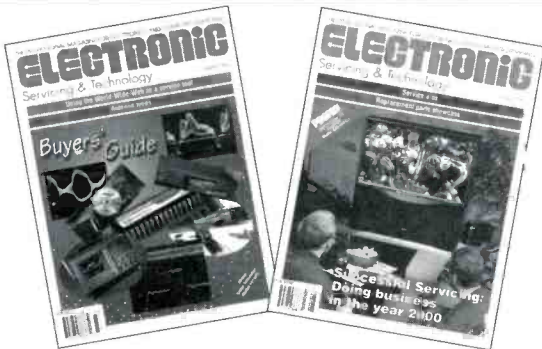

Send \$4.00 Per Issue

When ordering back issues include the following information: Name, address, city, state & zip. Please make a list of the issues you're requesting. When paying by credit card send the number along with the expiration date. Check, Money Order, Mastercard, VISA, Discover and AMEX accepted.



For Faster Service
Fax 1-516-681-2926
Electronic Servicing & Technology
25 Newbridge Road
Hicksville, NY 11801

Complete your collection today.

Electronic Technicians Association - ETA and Satellite Dealers Association - SDA present The Ultimate Customer Service Specialist Study Guide

CSS-2

The second edition of this popular CSS Study Guide is now in print.

-  Twice the number of pages
-  Twice the chapters
-  Dozens of new practice quiz questions

Sales-marketing-service relationships; Technoliteracy; Safety; Company standards; Dependability; Teamwork; Work ethics; Problem solving; Company loyalty; Telephone techniques; Controlling your emotions; Communications; Record keeping; Safety; Decision making; Customer service techniques; Hygiene, and more

**No Service Business Should be Without One of These
Unique Guides to World Class Service!**

to order
Call 800 288 3824

eta@indy.tdsnet

ETA-I

602 N Jackson, Greencastle, IN 46135

Circle (72) on Reply Card

Home automation

by Jim Van Laarhoven

Technology plays such an extensive role in our everyday life; it would be difficult to conceive what we would do without our pagers, cell phones, and computers. Inevitably, this same technology will someday be integrated into most homes. In some ways, it already has been. Security systems, entertainment, and a host of other sophisticated electronics devices are very common in a majority of our homes today. Taking this one step further; there are companies that have been working for years on the technology of home automation. One of those companies is LiteTouch Inc. and their computer-based systems will be the main topic of this article.

Home automation can consist of a myriad of different features including home entertainment, lighting, and environmental control to mention only a few. We will concentrate on lighting, but will mention other areas of integration of the LiteTouch 2000 system (Figure 1).

Features of a home automation system

Here is a brief overview of some of the features of this system:

- Programmable computers with RS232 input capability,
- A telephone interface that allows control of your house system remotely,
- Infrared and radio remote controllers,
- External activation from non-system hardware (garage door openers, security, motion detectors, optical sensors, etc.).

Starting with the Central Control Unit (CCU), we will briefly go through some of the components in this system.

The central control unit

The CCU processes information from all of the electronic switch stations and control modules in the system (these components are illustrated on the upper left side of Figure 1). In addition, its non-volatile memory retains the programs that control both the switch stations and con-

Van Laarhoven is an independent technician and consultant for computer based lighting.

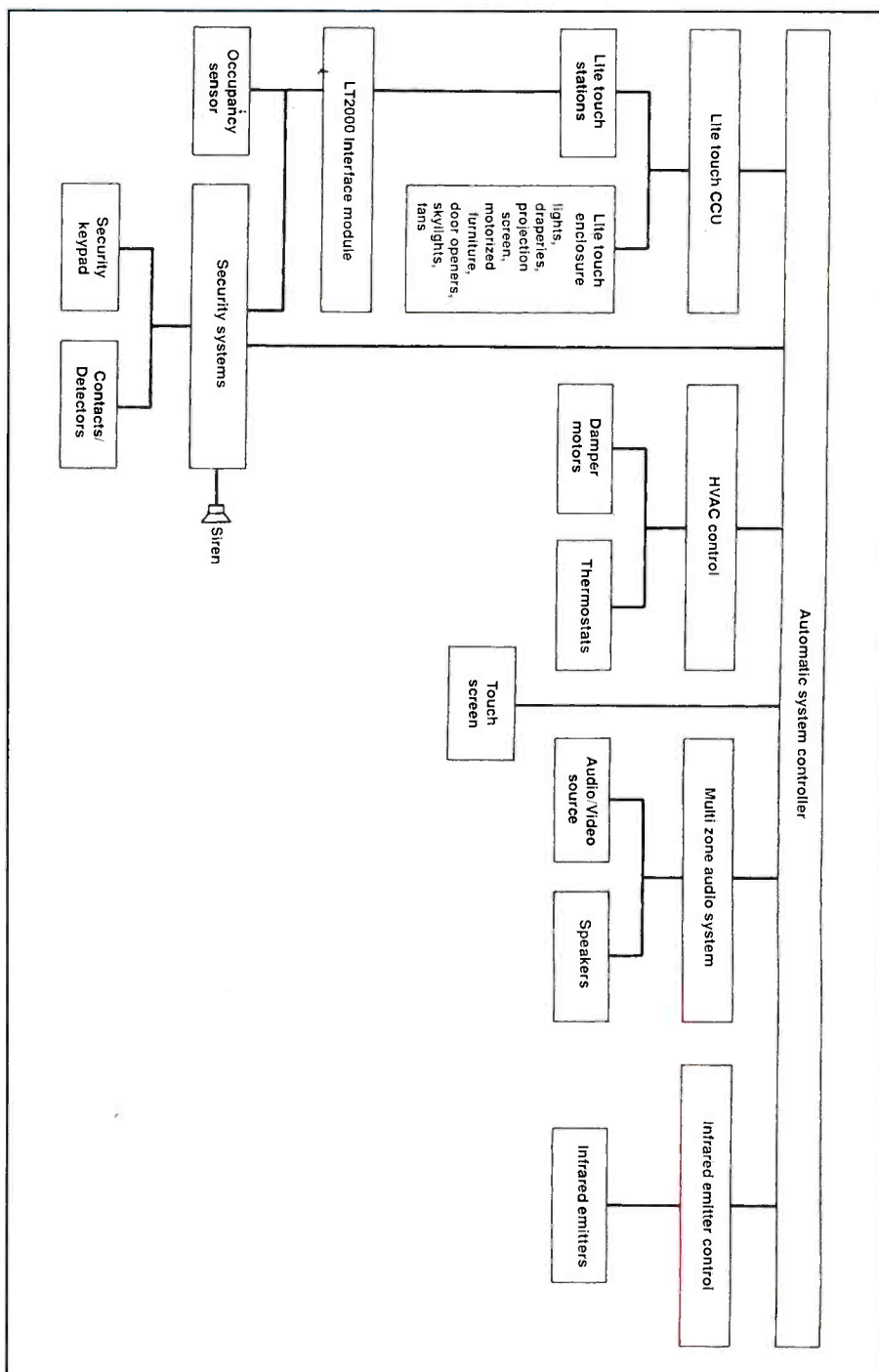

Figure 1. Modern technology has made it possible to automate the control of many functions in the home.

trol modules. One CCU can control up to 2304 separate switches and 2048 independent loads. When a switch is activated, either physically or electronically, a digital signal is sent to the CCU.

The CCU recognizes the MSD (most significant digit) and the LSD (least significant digit) of that particular switch or control station and checks the program assigned to it. It then sends a digital sig-

nal to the assigned control module (load) which also has a specific MSD and LSD. The control module then responds by activating the load in accordance with the information supplied from the CCU. The CCU checks with the switch and control module periodically to make sure that they are both responding in compliance to the program. Over-riding programs can also affect this status. If say, a timer program has instructions to dim that same load at midnight, an over-ride will occur. When that program is complete, it will comply with the previous input instructions.

What the CCU can do

There are numerous programs that the CCU, control stations, and control modules are capable of responding to. If a house has three-hundred loads, one switch can be programmed to turn on and off those three-hundred loads at once (this is a good security activation program). One such installation has a radio remote that is located in the owner's car. When they drive down their darkened driveway at night, they push one button and the whole house appears out of nowhere. It has quite an effect on your senses to experience a brilliantly lit house appearing instantly before your eyes.

In another installation, a TV lowers from the ceiling and turns on as you enter the room. This was accomplished by using the dry contacts of a heat sensor and a unit called a Data Input Module (Figure 2). This type of module acts more like a switch station than a standard control module (load controller). It is unusual to note that sometimes a switch can be activated that really does not exist! That sounds unlikely, but it is true. All you have to do is write a program for a hypothetical switch into the CCU and assign it to a control module load. Using the timer function, you then set a time for that hypothetical switch to come on. The CCU reacts to the command as if the switch were actually wired into the system by turning the assigned load on. This application has some very good uses, especially if for some reason you don't want somebody turning that switch off.

Basic system requirements

Every system must have at least a CCU, a power supply, a switch (control station), and a control module to be fully func-

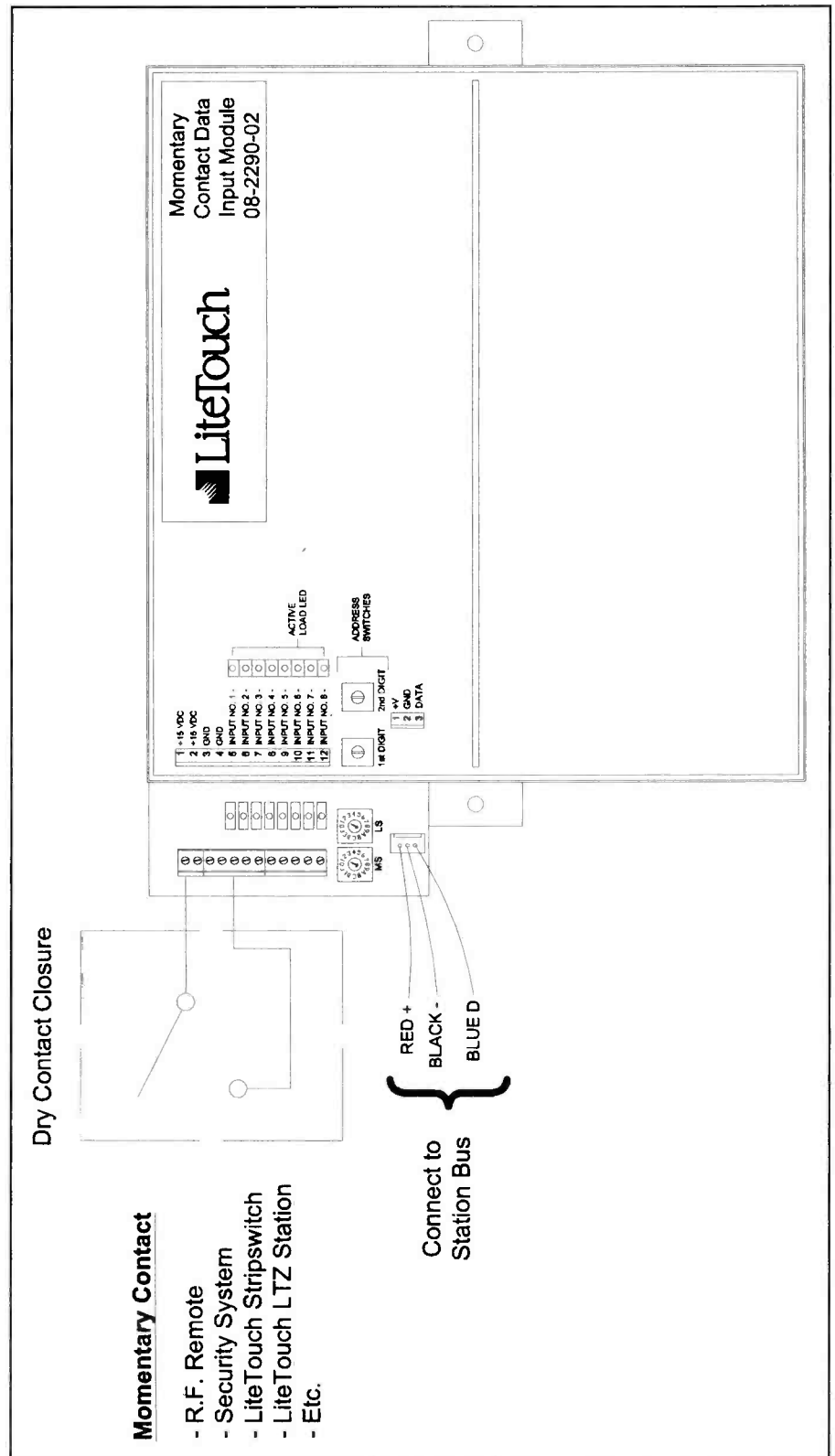

Figure 2. In one home automation installation, a TV lowers from the ceiling and turns on as you enter the room. This was accomplished by using the dry contacts of a heat sensor and a unit called a Data Input Module.

tional. Most moderate systems include a CCU, two to three dual power supplies, about twenty to thirty control station switches, and about 12 control modules (about 72 loads).

Every application is different depending on the size of the house and the design of the system. LiteTouch has design programs available that help you make the hardware decisions needed.

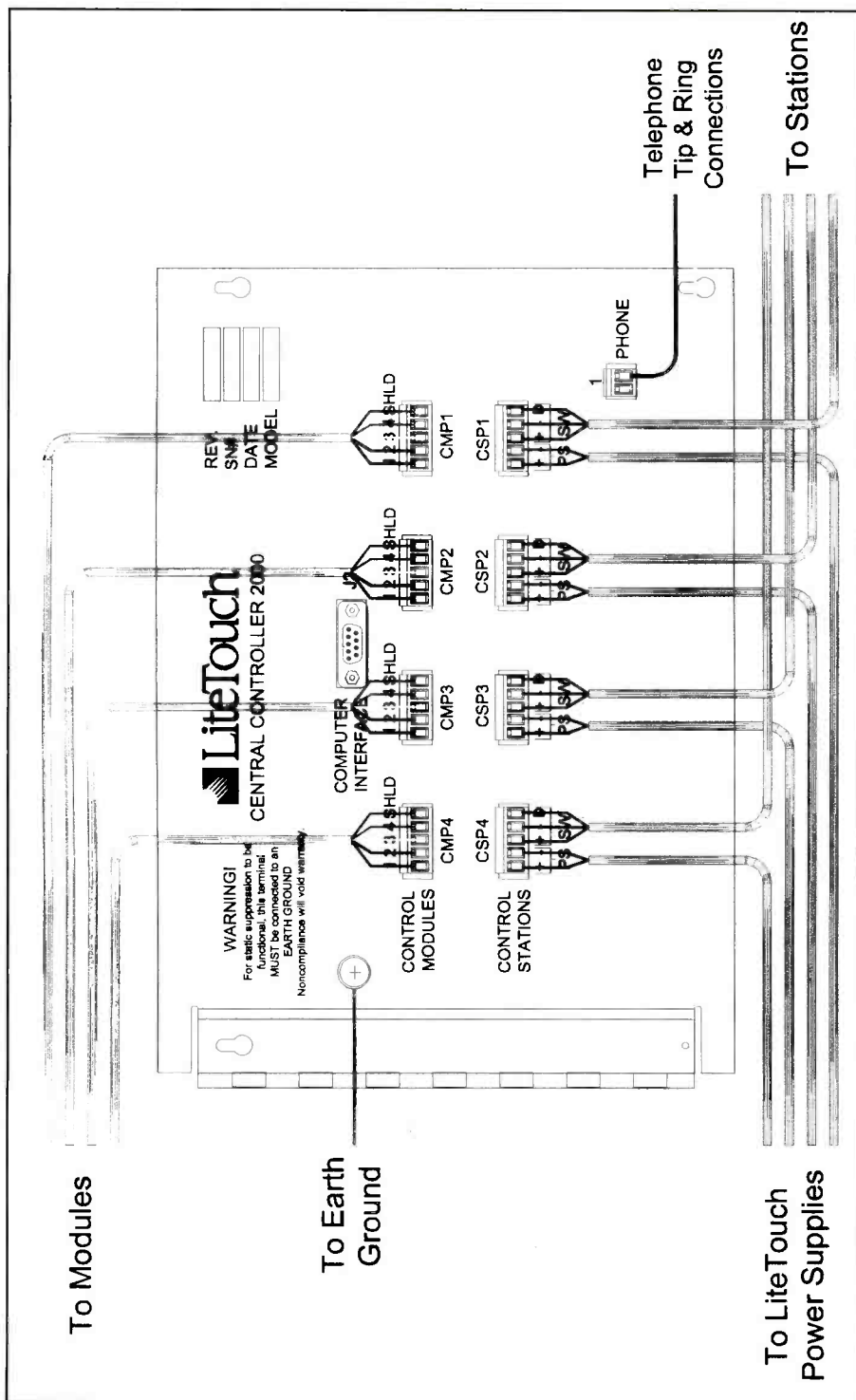

Figure 3. This wiring diagram shows how the central control unit (CCU) is connected to the various system modules.

The next section will cover in detail each component and some of the installation requirements of the system.

Software and programming

The standard CCU has a DOS-based software that uses EPROM (Erasable Programmable Read-Only Memory) technology. Programming inputs can be

accomplished on its mylar keyboard, or uploaded from any IBM-compatible computer via the CCU's RS232 port. Programming software is available that makes uploading from a separate computer fast and easy. The CCU normally has four switch (control station) ports and four communication ports located in the back of the unit (Figure 3 for wiring dia-

gram). It also has a telephone interface port located in the same location. This unit draws about 200mA of dc current, and in addition, handles the complete dc load to the control switches. If this load becomes too high due to high switch current or bad data, the CCU will automatically shut down the problem switch port. The rest of the house control switches will still operate on the remaining three ports. It should be noted that this unit retains its memory even if power remains off for long periods of time.

Exercising control

Control of your house can be accomplished from any location that has a touch-tone phone. A voice chip in the CCU announces that you are connected to the system, then the home owner inputs the switch address that they would like activated. The telephone interface software includes a password so unauthorized access to your computer is restricted. There are many other features of the CCU that are excluded from this article in the interest of covering a broad view of the system.

Switch wiring

The switches (control stations: Figure 4) are wired from the CCU ports via a 16-gauge, three conductor cable (cable approved by the manufacturer). This cable is then looped between control stations. The termination of these three conductors, plus a pigtail for the control switch, needs to be in parallel. Voltage drop should be a concern when installing this wiring. The company warns not to put more than twenty control stations on a single port run, however, it is better to err on the side of efficiency. If you have 40 control stations, split the port runs into four areas so that only ten control stations are controlled by each port. Fan-out is a very important aspect when it comes to switch installation.

The control stations

The control stations come in a variety of colors and switch configurations (Figure 5). Generally, the limit on the amount of buttons that can be included on one control station is nine. Switches are addressed by means of an MSD and LSD (Figure 4). This is the recognition address that will be programmed into the CCU that will later be assigned control module

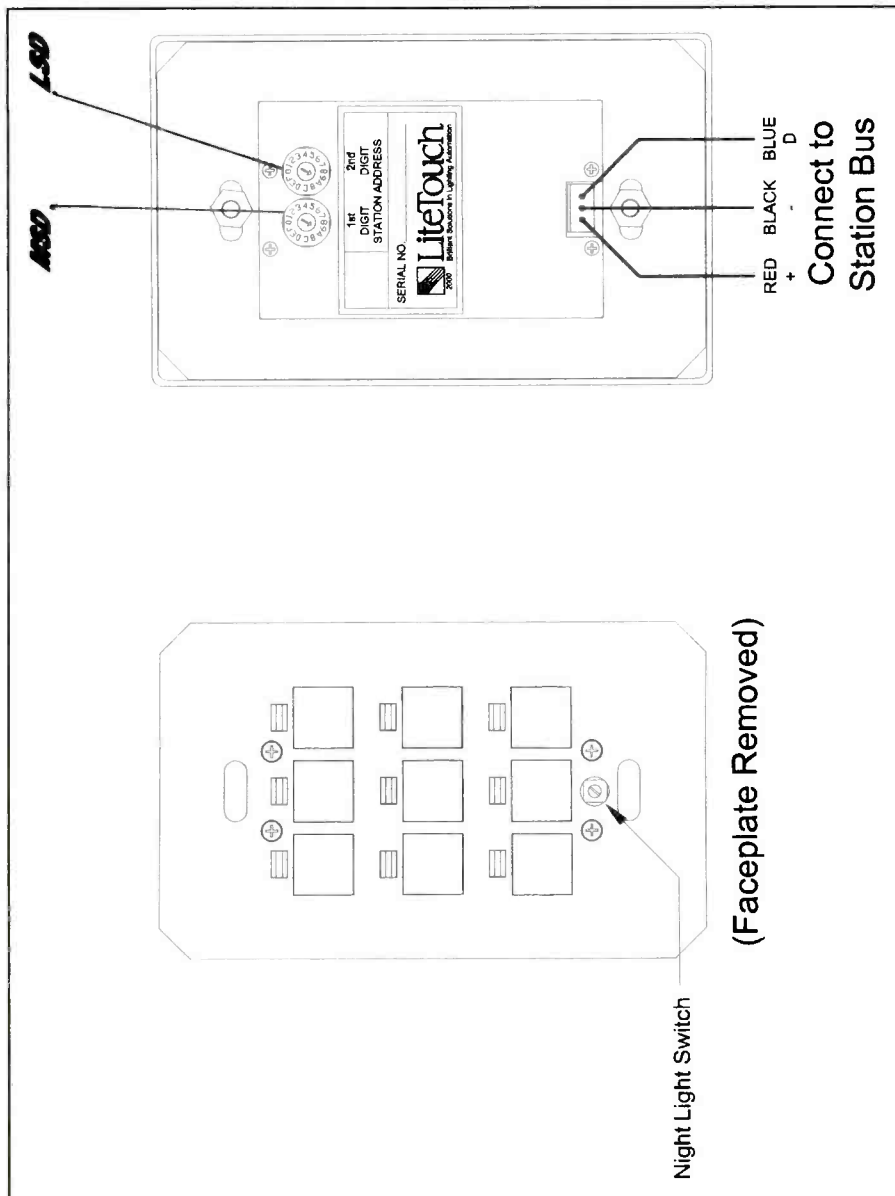

Figure 4. The switches are wired from the CCU ports via a 16 gauge, three conductor cable (cable approved by the manufacturer). This cable is then looped between control stations.

load addresses. LEDs on the control station confirm control module activation (confirm the load is actually on).

Control modules are the interface between the CCU and the line-load high voltage. A shielded 24 gauge, two-twisted pair cable runs from a port in the back of the CCU to a transorb board (for surge suppression) next to the control modules. Another cable is then run from the transorb board to the data-in of the first module (Figure 6). Jumpers are then installed from the data-out of the first module to the data-in of the next. This continues until all of the modules are connected to the communications port of the CCU. Control modules come in a variety of forms: Relay (Figure 6), dimmer (Figure

7), fluorescent, and other types of modules are used depending on the load requirements of the system. They are addressed exactly like the control stations with an MSD and LSD. For instance: switch address 01-2 (the Zero is the MSD and the One is the LSD). The number Two represents the button position on switch 01. This switch is then programmed to activate control module address 15-6 (the One is the MSD and the Five is the LSD). The number Six is the sixth output load on the control module. Licensed electricians should make the high-voltage connections to these modules so that the installation complies with national and local electrical codes (see line feed and load connections on Figures 6 and 7).

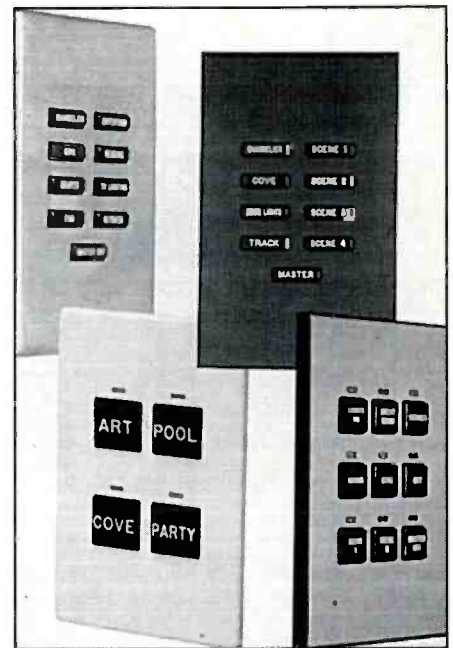

Figure 5. The control stations come in a variety of colors and switch configurations.

One more thing should be mentioned before ending the component install area of this article. LiteTouch can provide you with lightning protection equipment for this system. The electronics that are used in this system are susceptible to transient spike damage.

Programming the CCU

Programming the standard CCU is simple once the principles are understood. It resembles most PLCs (programmable logic controllers) as far as menus and data input. From the main screen, we will go through a few programming steps. Looking at the main screen, you will see the LiteTouch name and the time/date displayed. Press Enter to activate main menu. It will then give you the main menu options and free memory available in a percent amount. Press the number One key, which is: Switch and Load Menu.

Then press One again, which is: Examine/Update Switch Assignment. It will then prompt you: Control Station Address>. Push the Zero and One keys; which is the switch address used previously in this article. It will then prompt you: Switch Position Number>. Push the number Two key. The CCU will then access the program for that switch and position. Push the number One key again. This option is to view and modify the switch. It then will display the control

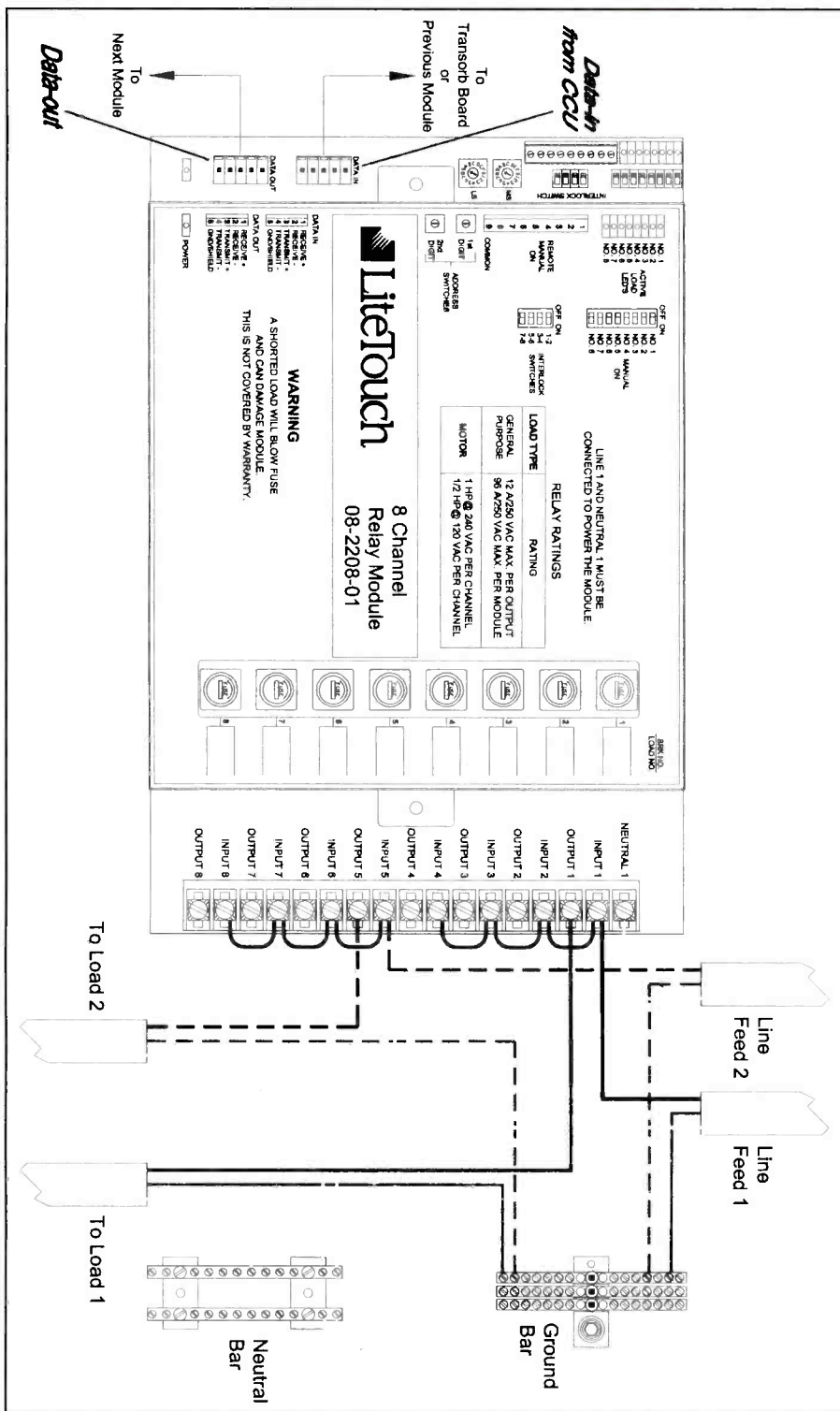

Figure 6. Control modules are the interface between the CCU and the line-load high voltage. A shielded 24 gauge, two-twisted pair cable runs from a port in the back of the CCU to a transorb board (for surge suppression) next to the control modules. Another cable is then run from the transorb board to the data-in of the first module (shown here).

module address(s) assigned to that switch and also what kind of switch it is. It could be a dimmer, toggle, momentary, master, or a scene preset. There are others, but we will choose from one of these. We will choose, master. It will ask what kind of master: on/off, toggle, or dimming. We

will choose dimming. It will then ask us to choose the loads we want assigned to it. We will choose loads from the control module we mentioned earlier in the article. Press Fifteen, then press Enter. Press Six, then press Enter. It will then ask if you wish to assign more. Press One for

yes. Then press Fifteen and Enter. Then press Two and then Enter. It will then save this information. Press the Back key until you see the LiteTouch name again. The switch is now programmed. If you were to go to that particular switch and push the button, you would see the two loads that you programmed turn on. If you held onto the button, you would see them both dim in unison.

There are many options when it comes to programming, but the above example will get you started.

Troubleshooting

Home automation systems are reasonably complex systems. Moreover, as with any electronics product, they are susceptible to failure, or faults. Some problems may be caused by the hardware, and some problems may have been caused during installation or programming. Following are some problems that may be encountered with one of these systems, and some steps to troubleshoot and correct them.

Switch will not make a load turn on or off

When a switch will not make a load turn on or off, you probably have a communication problem. Communication trouble can be more prevalent than other types of problems in this system, so we will concentrate on that area. First, check to see if the LED is turning off and on when you depress the switch button. If it is not, you most likely have a bad switch somewhere on that port. Inspect the power supplies to make sure the green LED's that show proper operation are lit. Then access the CCU. From the main screen, press Option. Then press the number Three for: Control Station Communication Test. The CCU will warn about a few things, like the system will be inoperative during this test. Press any key to continue. The CCU will then test all parts of the switch port system. It will display port errors and will display any switches that are not reporting. This program is helpful, but sometimes inconclusive.

The next step is to measure port voltages on the back of the CCU. Starting with port CSP1 (some ports may not be used; you do not have to measure the voltages on these), place voltmeter probes on the port conductors that are marked plus and minus above the bracketed area marked SW. Note the voltage. It should be around

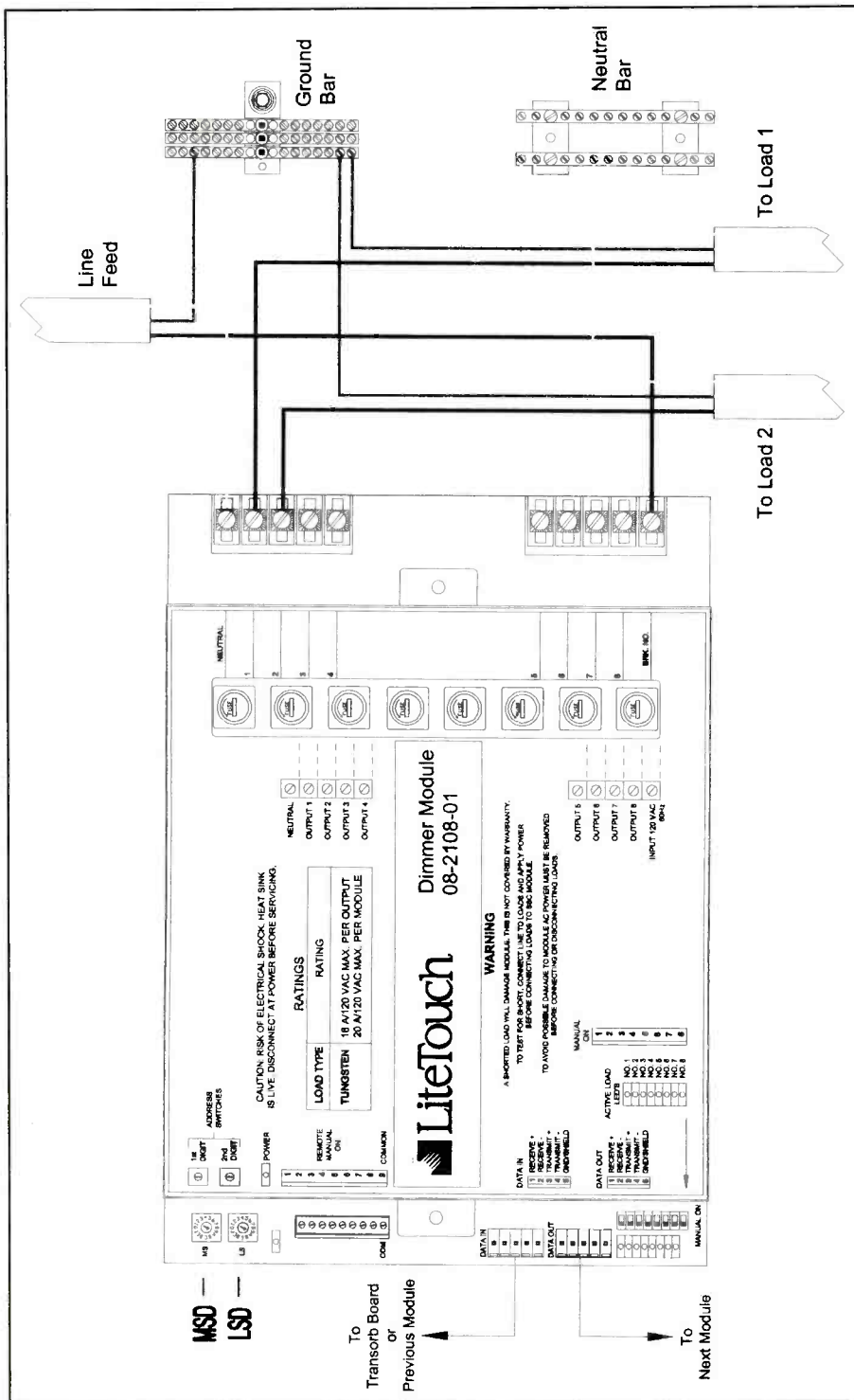

Figure 7. Control modules come in a variety of forms: Relay (such as the one in Figure 6), dimmer (shown here), fluorescent, and other types of modules are used depending on the load requirements of the system.

18Vdc to 20Vdc. Then move your positive probe to the port conductor marked D (this is for data). It should not measure more than 1V lower than your previous measurement. If it does, you most likely have a bad control station. It is a painstaking job sometimes, but the best way to find a bad switch, is to pull the control stations out one at a time and disconnect

them. Each time you disconnect, check to see if the voltages have returned to their proper values (you can do this measurement at the switch's termination wires). When they have, you have found the faulty switch. The CCU will automatically start using that port again when the bad switch is removed. When replacing the control station, remember to change

the MSD and LSD to match the digits of the faulty switch.

Switch LED turns on and off, load won't turn on

We will use the previous switch problem for another example. This time the switch LED is turning off and on when you depress the button, but the load is still not turning on. First, check the circuit breakers in the main electrical panel to make sure one of them isn't tripped. Then access the CCU. Press Option at the main screen, then press Two for Control Module Communications Test. The CCU will test the control modules much like it tested the control stations earlier. It will then display how many of the hundred interrogation loops were missed by any of the control modules. This test will probably lead you in the right direction. If all of the control modules responded except for sixteen, seventeen, and eighteen, you probably have a communication cable or a bad control module starting at module fifteen or sixteen. All communication will be affected past the bad control module. In this situation, a cable connection had come loose (I don't know how either!). Snugging the connector back into the data-out port on the number fifteen module restored communication. The switch now controlled the load properly.

As every technician knows, it is impossible to cover every conceivable troubleshooting situation, especially when a system is as complex as home automation. These examples mention just a few of the possible symptom/cures.

A full home automation system

Another system that this company offers is the 5000LC. This system can integrate with the 2000 system with just a few hardware and software changes. The 5000LC integrates audio visual, environmental control, security, and other systems for full home automation. It operates with Windows 95 and 98N/T and offers a microprocessor back-up in case the main one fails. One of the features this new system offers is a rack mount design. It allows for future expansion as new home automation technology becomes available.

Home automation systems are developing all of the time. Just like the electronics industry as a whole, it is growing. It will be interesting to see what's in store for the future. ■

Replacement parts/servicing information sourcebook

by the ES&T Staff

At one time, the manufacture of a TV set was a major undertaking. Every step in the manufacture was done by hand, and manufacturers of sets for use in this country were located in this country. At that time, the manufacturer of any product was readily identifiable by the information on the product, and there was no difficulty locating them. As long as that was the case, finding sources for service literature and replacement parts when the products needed service was a relatively easy procedure.

Today, in many instances TVs, VCRs, and many other consumer electronics products are handled like so many jelly beans. Some factory in an offshore country churns out product. Some entrepreneur travels to that factory, buys a carload of product, puts it on a ship bound for the west, and, voila, one day very low priced units show up in a discount store. The consumer buys the product, and when it fails, brings it to his local service center expecting it to be repaired.

Now the problem begins for the service manager. Who made the set? Do they have a presence in this country; someplace where he can go to get service literature and parts? Sometimes the answer is yes. That's good. Sometimes the answer is no. That's not so good.

In the case when the answer is no, the service center may still be able to determine the identity of the company that

actually built the product. That company may or may not be able to provide service literature on the unit in question. If the product is identical to one sold by the company under their own brand name, the company may be willing to furnish service literature for the similar brand product. On the other hand, they may not make a product anything like that orphan brand, and may have left it up to the company that bought the product to generate service literature.

In the first instance, you're in luck and will be able to fix the product. In the second instance, unless you can locate the company that imported the sets, and they have service literature to sell, you'll have to service the product without a manual, or return it to its owners.

Other factors that make service difficult

These are only a few of the factors that make it difficult for the average service center to locate and obtain service literature and replacement parts for some products. Some of the other reasons are:

- Companies move, and after a set amount of time the post office doesn't forward mail.
- Some companies are small and have a very low profile in the marketplace, so they're just hard to locate.
- Many private brands of consumer electronics products have little or no support.

• An offshore manufacturer may sell and support products in the U.S. for a period of time and then leave the market. In some cases, these companies will have sold their stocks of replacement parts to a distributor in the U.S., but how do you know to whom?

• Some companies don't wish to have independent service companies service their products, so they refuse to provide service literature and replacement parts to the independent.

Clues to the identity of the manufacturer

If you encounter a product that has an unfamiliar name and no other information, such as an address or phone number, to help you determine its origins, you may still be able to find out how to locate its manufacturer or distributor. Two pieces of information that can help make such an identification are the FCC (Federal Communications Commission ID number and the UL (Underwriters Laboratories) code number.

Here's some help

Because consumer electronics servicing presents so many difficulties in simply locating replacement parts and service information, each year in the December issue, we publish a replacement parts and servicing information sourcebook that provides service compa-

2000 International

CES

THE SOUCE FOR CONSUMER TECHNOLOGIES

Please send me a copy of the 2000 International CES Directory as mentioned in **ES&T**.

Enclosed is a check for \$25.00, Payable to the Consumer Electronics Show. (For **ES&T** readers only. Regular value is \$100.00.)

Print Copy

CD ROM

Name _____

Company _____

Address _____

City _____ State _____ Zip _____

Phone _____ Fax _____

E-mail _____

Mail to: CES, Att: CES Registration
2500 Wilson Boulevard, Arlington, VA 22201-3824

FCC ID numbers

Code	Prefix Manufacturer	Code	Prefix Manufacturer
A26	Alpine	ANV	Capetronic Int'l Corporation
A3D	NEC	API	Harman Kardon Inc
A3L	Samsung	ARS	AOC Int'l of America Inc
A6R	Yamaha	ASH	Akai
A7R	Orion	ASI	Victor Company of Japan
AAL	Phone Mate	ATA	Sharp
AAO	Radio Shack	ATO	Zenith Electronics Corporation
AAV	Midland International Corporation	ATP	Advent Corporation
AB6	Northern Telecom	AZ4	Motorola Inc.
ABL	Hitachi	AZD	Canon
ABW	JC Penney	B4S	A10 (USA) Inc.
ABY	Motorola	BBO	Cobra
ACA	Yorx Electronics	BCG	Apple Computer
ACB	Phonotronics	BEJ	Goldstar
ACJ	Matsushita	BFY	Shintom Co. Ltd.
ADF	Carterfone	BGA	Audiovox Corp
ADT	Funai	BGB	Mitsubishi
AES	Uniden	BJM	Tatung Company
AEZ	Sanyo	BO7	Sanyo Fisher
AFA	Fisher	BOU	Philips
AFL	Sharp	C3K	Microsoft
AFR	Curtis Mathes	C5F	Daewoo
AGI	Toshiba	C9S	Fujitsu Limited
AGV	Montgomery Ward	CKL	Hyundai Electronics
AHA	RCA	CLV	Recoton
AIH	Litton Microwave Cooking Products	CNT	Compaq Computers
AIX	Sylvania	EOZ	Shintom
AJD	Pioneer Electronics Corp.	E2K	Dell Computer
AJU	GE	F67	Ampex
AJX	Toshiba (Cordless phones)	FOD	Packard Bell
AK8	Sony	FYL	Sampo
AKC	Superscope Inc	G9H	Thomson Consumer Electronics
AKE	Marantz Co Inc	GBU	3M
ALA	Wells Gardner Electronics Corporation	GQ8	Acer
ALI	Kenwood USA Corporation	HVM	Sanyo Fisher

Figure 1. Every VCR, personal computer, cordless telephone, microwave oven, or other product that could possibly cause electromagnetic interference must carry an FCC ID number. The first three characters of that ID uniquely identify the manufacturer of the product. This is a listing of manufacturer vs. FCC ID number prefix, alphanumerically by code.

nies with several tools to help them overcome these problems. This sourcebook is published annually because so many changes take place within a twelve month period that the list is largely out of date by the time a year has gone by.

Moreover, things change in the industry and in the regulatory organizations. For example, as will be discussed later, last year the organization of the FCC web site was like pulling teeth in order to get information on a company and its products. Today, that information is available in abundance, and this article tells you how to access it if you have a personal computer and an internet provider.

This sourcebook contains the following sections:

- A list of suggested references
- A list of FCC (Federal Communications Commission) ID number prefixes that identifies the manufacturer of any

product that bears an FCC ID number

- An identification for the website for the FCC. At this site you can browse, and search for manufacturer identification for a given FCC ID number. Last year in this article, we wrote: "At one point it was possible for visitors to this site to download records that contain FCC ID numbers vs. company name, address, etc. At the moment, this capability seems to no longer be in effect." The good news this year is that this capability has been restored. Those databases are again downloadable, in the form of database files.

- An updated list of UL (Underwriters' Laboratories) ID numbers

- An updated list of manufacturers with addresses and telephone numbers.

Finding replacement parts

Here's a list of references that are useful in tracking down the manufacturer, or

parts distributors. We think that every electronics servicing facility should have these documents:

Consumer Electronics Replacement Parts Source Book

Consumer Electronics Manufacturers Association,
Electronic Industries Association
2500 Wilson Boulevard
Arlington, VA 22201

This document costs \$8.00, including shipping and handling.

Electronic Industry Telephone Directory (Or some equivalent)

Harris Publishing Company
2057-2 Aurora Rd.
Twinsburg, OH 44087-1999
216-425-9000

This will cost around \$50.00 (Or you might be able to get a copy free from your distributor.)

FCC ID numbers

Manufacturer	First 3 Characters of FCC ID	Manufacturer	First 3 Characters of FCC ID
3M	GBU	Mitsubishi	BGB
A10 (USA) Inc.	B4S	Montgomery Ward	AGV
Acer	GQ8	Motorola	ABY, AZ4
Advent Corporation	ATP	NEC	A3D
Akai	ASH	Northern Telecom	AB6
Alpine	A26	Orion	A7R
Ampex	F67	Packard Bell	FOD
AOC Int'l of America Inc.	ARS	Philips	BOU
Apple Computer	BCG	Phone Mate	AAL
Audiovox	BGA	Phonotronics	ACB
Canon	AZD	Pioneer Electronics	AJD
Capetronic Int'l Corporation	ANV	Radio Shack	AAO
Carterfone	ADF	RCA	AHA
Cobra	BBO	Recoton	CLV
Compaq Computer	CNT	Sampo	FYL
Curtis Mathes	AFR	Samsung	A3L
Daewoo	C5F	Sanyo	AEZ
Dell Computer	E2K	Sanyo Fisher	BO7, HVM
Fisher	AFA	Sharp	AFL
Fujitsu	C9S	Sharp	ATA
Funai	ADT	Shintom	E0Z, BFY
GE	AJU	Sony	AK8
Harman Kardon Inc	API	Superscope Inc.	AKC
Hitachi	ABL	Sylvania	AIX
Hyundai Electronics	CKL	Tatung	BJM
JC Penney	ABW	Thomson Consumer Electronics	G9H
Kenwood USA Corporation	ALI	Toshiba	AGI, AJX
LG Electronics	BEJ	Uniden	AES
Litton Microwave Cooking Products	AIH	Victor Company of Japan	ASI
Marantz Co Inc.	AKE	Wells Gardner Electronics Corporation	ALA
Matsushita	ACJ	Yamaha	A6R
Microsoft	C3K	Yorx Electronics	ACA
Midland International Corporation	AAV	Zenith Electronics Corporation	ATO

Figure 2. To make it easier for readers who may be interested in locating the FCC ID prefix of a particular manufacturer, here is the same information presented in Figure 1, alphabetically by manufacturer name.

The Howard W. Sams and Company Annual Photofact Index

Available from your distributor, or directly from:

(This document is available in printed form and on computer floppy disk)

Howard W. Sams & Company
2647 Waterfront Parkway East Drive
Indianapolis, IN 46214-2041
800-428-7267

Consumer Electronics Show (CES) Directory

Electronic Industries Association
Consumer Electronics Group
2500 Wilson Blvd.
Arlington, VA 22201
703-907-7500

The CES directory includes over 1,000 manufacturers, brand names, products, and key personnel. The best way to get a copy of this directory is to attend the Consumer Electronics Show in Las Vegas, January 6 through January 9 1999. It comes with the price of attendance. For further information about CES, write to

the address above, or call the listed number and ask for CES Registration.

If you can't get to the show, limited numbers of copies of the directory will be available from the above address. Limited quantities of the CES Show directory will be available at a reduced price to **ES&T** readers who send in the coupon in this issue. Quantities are limited, but the EIA/CEMA will fill as many orders as possible.

A VCR model number and parts reference

Another invaluable reference is published by the International Society of Certified Electronics Technicians (ISCET): a VCR model number and parts cross reference. The Eighth Edition of the VCR Cross Reference Manual is still available in both paper and software editions from ISCET. It has not been updated this year.

The software allows the user to search by manufacturer for model numbers and

description for part numbers, and a sub-search by manufacturer and part description is also a feature of the program. The editing sequence for parts shows on screen all the substitutes for the part entered.

The cross reference, which lists equivalent model numbers among brands and equivalent part numbers among brands is now available from ISCET. This three-hole punched, 144-page, expanded edition includes more than 6,000 parts and 1746 models. About 50 brands are covered in the manual, including RCA, GE, Panasonic, Quasar, JC Penney, Canon, Magnavox, Philco, Sylvania, and others. Typically, this manual would enable a user to repair say, a Canon VCR with a Panasonic part, using RCA service data. The price of the paper version was originally \$29.95, plus \$3.00 shipping. It is now on sale, while quantities last, for \$17.95, plus \$3.00 shipping. The software version on 3-1/2 inch floppy diskette is \$39.95 plus \$3.00 shipping.

The Cross Reference book or disk can

UL listing number to VCR manufacturer (Unofficial)

UL Number	Manufacturer	Brand Names
146C	Goldstar	
153L	NEC	
16M4	Samsung	Supra, Multitech, Unitech, Tote Vision, Cybrex, GE RCA, Sears
174Y	Toshiba	Sears
238Z	Hitachi	RCA, GE, Penny, Pentax
270C	Sony	
277C	JVC	
282B	Sharp	
289X	Emerson	
333Z	Symphonic	Teac, KTO, Realistic, Multitech, Funai, Porta Video Dynatech, TMK
336H	RCA	
347H	NAP	
43K3	Kawasho	
403Y	Fisher/Sanyo	Realistic, Sears
436L	Quasar	
439F	JVC	Zenith, Kenwood, Sansui
444H	Zenith	
44L6	TMK	Emerson, Lloyds, Broksonic
504F	Sharp	Wards, KMC
51K8	Portavideo	
536Y	Mitsubishi	Emerson, Video Concepts, MGA
540B	GE	
570F	Sony	Zenith
623J	Sampano	
628E	Samsung	MTC, ToteVision
679F	Panasonic	RCA, GE, Magnavox, Quasar, Canon, Philco
723L	Sanyo	
727H	Hitachi	
74K6	Funai	
781Y	NEC	Dumont, Video Concepts, Vector, Sears
828B	Panasonic	Olympus
843T	Magnavox	
86B0	Goldstar	Realistic, JC Penney, Tote Vision, Shinton, Sears,
	Memorex	
873G	Mitsubishi	
41K4	Portland	

Figure 3. The UL listing number on a consumer electronics product identifies the manufacturer who made it. Here's a partial listing of UL numbers vs. manufacturer.

be ordered from ISCET, 2708 West Berry, Fort Worth, TX 76109; Telephone: 817-921-9101.

This two-part reference will help any servicing organization that services VCRs to cross reference among different brands made by the same manufacturer. Part 1 of this reference will allow the user to determine, when he has a product in for servicing, if it's possible that it's identical, or almost identical, to a product for which he already has a service manual. Part 2 of the reference cross references parts, so that if you can't find a particular part number for a product you are servicing, you may find that you have it on hand

under a different part number for another manufacturer's product.

The FCC ID number can help you find a manufacturer

Most consumer electronics products, carry clues as to who the manufacturer is. An FCC ID number, for example, appears on every VCR and computer, and any other product that might generate electromagnetic interference. The first three characters of this number, letters, or a combination of letters and numbers, identifies the manufacturer of the product. If a technician is faced with a product on the bench whose name he doesn't recognize,

What's Your Best Servicing Value? The magazine that makes money for you!

THE PROFESSIONAL MAGAZINE FOR ELECTRONICS AND COMPUTER SERVICING

ELECTRONIC

Servicing & Technology



As an electronic servicing professional, it's crucial for you to keep current in an industry that's always growing and changing.

Each month, *ES&T* brings you how-to service articles on TVs...VCRs... Computers... CD players...Microwave ovens...Audio products and more. It's the information you need to do your job every day.

Regular columns and special features from experts will make you more efficient – and more profitable – in no time. Plus, our monthly PROFAX, a FREE 8-page pull-out of popular TV, VCR and computer schematics, makes *ES&T* an even greater value.

Subscribe today to the only magazine devoted to you!

SUBSCRIBE TODAY!!

United States	
1-yr (12 issues).....	\$26.95
2-years (24 issues).....	\$49.95
Canada/Mexico	
1-yr (12 issues).....	\$36.95
2-years (24 issues).....	\$69.95
Foreign Air Post	
1-yr (12 issues).....	\$44.95
2-years (24 issues).....	\$85.95

When ordering include: Name, address, city, state, zip. Check, money order, MasterCard, VISA, Discover, and American Express accepted. Send credit card number along with expiration date. If renewing, send a label along with your request.

Send all Subscription requests to:
Electronic Servicing & Technology
25 Newbridge Road, Hicksville,
NY 11801 Ph: 516-681-2922
FAX: 516-681-2926

and if it bears an FCC ID number, he may look the number up in a list of such numbers and determine who the manufacturer was, and determine an address and telephone number.

This is a very helpful bit of information, but it might, or might not, yield the information that the technician needs. For starters, the name of the manufacturer might or might not be the same as the name on the product. The address and telephone number in the FCC database might be up-to-date, or it might not. The information in the database is the information that was current when the manufacturer provided the communications interference information concerning the

product to the FCC.

Now, it is possible for computer users to obtain this information easily from the FCC via the internet.

Currently, the FCC operates a website from which it is possible to obtain a great deal of information about the FCC and its operation. It is again possible not only to look up individual FCC ID numbers, but to download the entire database of FCC ID numbers for any year from 1998 back to 1987. Each file is a .dbf file, compressed into a .zip file. You can unzip the file and load it into any compatible database program and search for any information you might need.

Two web site addresses are included

here: the main FCC website, and the one that contains the Equipment Authorization Data Files (eadf). You might try the main site, but unless you know exactly where you want to go, it's not easy getting from there to the eadf page (at least it wasn't for me). The main site is www.fcc.gov. Actually, you might want to have a look at that site because there's a lot of interesting information about FCC activities there. But if you want to get to the eadf site (this is an ftp, or file transfer protocol, page) go directly to ftp://ftp.fcc.gov/pub/Bureaus/Engineering_Technology/Databases/eadf.dat/.

Actually, the FCC ID number contains information other than just that needed to identify the manufacturer of a product. The first three characters of the ID number is enough to tell you what company made the product. This article lists a number of FCC ID number three-character prefixes and the name of the manufacturer of the products that bear that number. We have added some numbers over and above those that were included in our previous list in the December 1998 issue so that the list is about 20 percent larger this year.

Unfortunately, manufacturers of television sets have not, for some time, been required to apply for FCC authorization for their products, because TV sets are no longer considered to be potential sources of communications interference. Because of this, when you run into a hard to identify TV set, you may not find an FCC ID number on it.

A rough count of the 1998 FCC eadf suggests that there are over 300 individual product types that carry FCC ID numbers. The products include VCRs, VCPs, magnetrons, even a hair remover. That number is a little misleading, because similar products that operate at different power levels or different frequencies carry different FCC ID numbers. An actual count of the number of unique manufacturer names in the database shows that there are individual identifiers for 521 companies.

A private company has downloaded this information and makes it available in the form of a compact disc. The address and telephone number for this company are:

M.I. Technologies:
3310 E. Peterson Road
Troy, OH 45373
937-335-4560



ORGANIZE AND PROTECT YOUR COPIES OF

Electronic Servicing & Technology

Now there's an easy way to organize and keep copies of your favorite magazine readily available for future reference.

Designed exclusively for **ES&T** by Jesse Jones Industries, these custom-made titled cases and binders provide the luxury look that makes them attractive additions to your bookshelf, desk or any location in your home or office.

Whether you choose cases or binders, you'll have a storage system that's durable and well organized to help protect your valuable copies from damage.

Quantity	Cases	Binders
One	\$ 8.95	\$11.25
Three	\$24.95	\$31.85
Six	\$45.95	\$60.75

Add \$1.50 per case/binder for postage and handling. Outside USA \$3.50 per case/binder. (U.S. funds only)

- Cases and binders designed to hold a year's issues (may vary with issue sizes).
- Constructed of reinforced board, covered with durable red leather-like material.
- Cases V-notched for easy access.
- Free personalization foil for indexing year.
- Binders have special spring mechanism to hold individual rods which easily snap in. This allows magazines to be fully opened for easy readability.
- Title hot - stamped in gold.

Call TOLL FREE 7 days, 24 hours

1-800-825-6690

Electronic Servicing & Technology Jesse Jones Industries, Dept. 95 EST
499 East Erie Avenue, Philadelphia, PA 19134

Original Manufacturer	UL listed code	FCC listed code
Akai	186Z	ASH
Fisher/Sanyo	403Y	AFA
Funai	333Z, 51K8	ADT, EOZ, BFY
Goldstar	86BO	BEJ
Hitachi	238Z	ABL, AHA
JVC	439F	ASI
Matsushita	679F	ACJ, AIX, AJU
Mitsubishi	536Y	BGB
NEC	781Y	A3D, E74
Orion-Emerson	44L6, 722	A7R
Philips	645Y	BOU
Samsung	16M4, 414K	A3L
Sharp	504F	ATA
Sony	570F	AK8
Toshiba	174Y, 84X7	AGI, G95

This is a FCC and UL guide to original VCR manufacturer that was published in the Taiko replacement video head guide July 6, 1994.

Figure 4. Sometimes it's difficult to find parts or servicing information for a product, even if you know who the manufacturer is. This listing, gleaned from a number of sources will provide some parts and technical literature sources for some products.

A recent telephone call to that company indicates that the information that exists in that listing is quite current.

Identification using the UL manufacturer's code number

Another source of manufacturer identification information is the Underwriters Laboratories code number. The manufacturer of every product that is submitted to Underwriters Laboratories for certification is assigned a unique code number that identifies who the manufacturer is. Figure 3 is a partial list of UL numbers and the manufacturers they represent.

Locating the manufacturers

It's not unusual for a servicing organization to have some difficulty finding the address and telephone number of a manufacturer of a product for which they need to order parts, even when the manufacturer is well known. Figure 4 is a listing of manufacturers, gleaned from **ES&T's** own records, the Consumer Electronics Replacement Parts Sourcebook, the NESDA Professional Electronics Yearbook, **ES&T** reader correspondence, many telephone calls by the **ES&T** staff, and other sources.

Information sources close to home

Those of you who are located in a city that has a good library system have a ready source of information available

free. For example, the **ES&T** staff regularly call the local library for information. References that they have available include the Thomas Catalog, a book called "Companies and their brands," and one called "Brands and their companies." And they're always pleased to receive a call for this kind of information. It's what they're there for. Try giving the reference librarian in your local library a call next time you have a question about who makes what brand of TV or VCR, or similar questions.

Look on the internet

Nowadays, another good way to find information on a company is to search for it on the World Wide Web. It's pretty much hit-or-miss, but this approach might just help you find the information you need. To find information on a company this way, just use whatever browser you ordinarily use, enter the name of the company that you want to search for, in quotes. Start by using the simplest search string, for example just the name of the company, without the word "Company," or "Inc."

And if you don't find any information at first, see if there are any other names that you might search under. For example, if you don't find anything under "Philips," try Magnavox, or vice versa.

Here are URLs for a couple of useful sites that list businesses:

- <http://www.companiesonline.com/>
- <http://www.hoovers.com/>

Coming in January

Personal computer servicing

Personal computers have become part of the lives of millions of households. For starters, they've become amazingly affordable. They're used for preparing correspondence, keeping track of the family budget, maintaining schedules, keeping an inventory of the household goods, books, CDs, etc. The internet allows people to do research, buy things, correspond with friends and family in a whole new way.

People these days have come to depend on the computer for a great deal of their information processing needs, and are willing to get them serviced when they need service. Savvy consumer electronics service centers now offer computer service, as well as help with setting them up and making the software work.

If your company hasn't yet considered servicing personal computers, this article will provide some reasons why you might want to look again. If your company is already servicing computers, this article will provide some handy hints and tips on both the business and technical side of personal computer service.

Service center management in the new century

All of the technology, such as personal computers and related items, have changed the way business is conducted today. Cellular telephones and pagers keep key personnel in touch at all times. Fax machines allow service centers to order parts and service information more efficiently than is possible via telephone. The internet allows service centers to research service documentation and parts on line, as well as to advertise their services via that system. Using personal computers, service centers can automate parts inventory, track products through the service process, billing, and more.

Many service centers have already discovered the benefits of embracing (and the pitfalls of not using) these technologies in the business. This article will examine some of these technological innovations, and their effect on the business of consumer electronics servicing.

1999 Annual Article Index

Look for the 1999 Annual Article Index. It will make it easier to find those elusive articles that we published in 1999.

10-Year Annual Profax Directory

If you're trying to find where you filed that Profax schematic diagram, this ten-year index, which we update and publish every year, should help.

Replacement Parts Source

Acoustic Research (AR)
(Now owned by Recoton)
527 Stone Rd
Benicia, CA 94510
707-748-5930

Action TV
(American Action TV)
100 Exchange Place
Pomona, CA 91768
909-869-6600

This company sells through truck stops and discount stores.

Adcom Service Corporation

10 Timber Lane
Marlboro, NJ 05546
732-683-2358

AIWA America Inc.

800 Corporate Drive
Mahwah, NJ 07430-2048
201-512-3600

**Akai American, Ltd. — See
Mitsubishi**

Alpine Electronics of America, Inc.

19145 Gramercy Place
Torrance, CA 90501
310-326-8000
800-421-2284

Altec Lansing Consumer Products

P.O. Box 277
Milford, PA 18337
717-296-4434
800-258-3288

AmPro Corporation

(Replacement parts for Kloss Novabeam and Videobeam)
5 Wheeling Ave.
Woburn, MA 01801
Sales: 617-932-4800
800-556-7733

AOC International

311 Sinclair Frontage Rd.
Milpitas, CA 95035
408-956-1070

Apple Computer

1 Infinite Loop
Cupertino, CA 95014
408-996-1010

Aristo Computers Inc.

6700 SW 105th Ave., Suite 300
Beaverton, OR 97008
503-626-6333

Atari Corp.

675 Sycamore Drive
Milpitas, CA 95035-7430
408-434-3700

Audio Technica U.S., Inc.

1221 Commerce Drive
Stow, OH 44224-1744
330-686-2600

Audiovox Corp.

150 Marcus Drive
Hauppauge, NY 11788-3723
516-231-7750

Barcus-Berry, Inc. (Division of BBE)

5381 Production Drive
Huntington Beach, CA 92649
714-897-6766
800-233-8346

Blaupunkt/Robert Bosch Corp.

2800 South 25 Ave.
Broadview, IL 60153
708-865-5200
800-266-2528

Canton/Luxman Electronics Corp.

915 Washington Avenue, South
Minneapolis, MN 55415
612-233-1150

Casio Inc.

570 Mt. Pleasant Ave.
Dover, NJ 07801-1620
973-361-5400

Channel Master

1315 Industrial Park Drive
Smithfield, NC 27577-6024
919-695-9286

CIE America, Inc. (C. Itoh)

2701 Dow Avenue
Tustin, CA 92780-7209
949-573-2942

Citizen America Corp.

831 S. Douglas St. Suite 121
El Segundo, CA 90245-4965
310-643-9825

Clarion Corporation of America

661 W. Redondo Beach Blvd.
Gardena, CA 90247-4201
310-327-9100

Columbia Data Products

P.O. Box 163088
Altamonte Springs, FL 32716-3088
407-869-6700

COMPAQ Computer Corp.

P.O. Box 692000
Houston, TX 77269-2000
281-370-0670

Connecticut Microcomputer

P.O. Box 186
Brookfield, CT 06804
203-740-9890
800-426-2872

Curtis Mathes Corp. (See Uniview)

Daewoo Electronics Corp. of America

120 Chubb St.
Lyndhurst, NJ 07071
201-460-2500

Dell Computer Corp.

1 Dell Way
Round Rock, TX 78682-7000
512-338-4400
Sales, Parts, and Warranties:
800-426-5150

Denon Electronics

222 New Road
Parsippany, NJ 07054
973-575-7810

Emerson Radio Corp.

9 Entin Road
Parsippany, NJ 07054
973-884-5800
Fax: 973-428-2019

Epson America, Inc.

20770 Madrona Ave.
Torrance, CA 90503-3777
310-782-0770

Fujitsu Ten Corp. of America

National Service Headquarters
19600 South Vermont St.
Torrance, CA 90502
310-327-2151 • 800-423-8161

Funai USA Corporation

(Also Symphonic)
100 North Street
Teterboro, NJ 07608-1202
201-288-2063

Gemini, Inc.

103 Mensing Way
Cannon Falls, MN 55009
800-533-3631

GoldStar Electronics Int'l, Inc.

See LG Electronics

GoVideo

7835 East McClain Drive
Scottsdale, AZ 85260
602-988-3400
Fax: 602-998-0381

Grundig/Lextronix Inc.

3520 Haven Ave., Unit L
Redwood City, CA 94063
800-872-2228

Harmon Kardon, Inc., JBL, Infinity

20211 Saticoy St.
Winnetka, CA 91306
800-645-7484

**Hitachi Home Electronics
(America), Inc.**

1855 Dornoch Ct.
San Diego, CA 92173
649-661-0227

Intek Global Corp.

(Formerly Midland International)
1690 North Topping
Kansas City, MO 64120
816-241-8400

International Jensen

25 Tri-State Int'l Office Center
Suite 400
Lincolnshire, IL 60069
800-753-6736

**JVC Service & Engineering Co. of
America**

Division of U.S. JVC Corp.
1700 Valley Rd
Wayne, NJ 07470
973-315-5010

Kenwood Service Corp.

Formerly Kenwood U.S.A., Corp.
National Parts Department
2201 E. Dominguez
Long Beach, CA 90801
310-549-7810

Kloss Video Corp. (See Ampro Corp.)**Kyocera Electronics, Inc. (Printers)**

2301 Cottontail Lane
Somerset, NJ 08873
908-563-4300

LG Electronics USA, Inc.

1000 Sylvan Ave.
Englewood Cliffs, NJ 07632
201-816-2000

Luxman Electronics Corp.

(See Canton/Luxman)

Marantz USA

440 Medinah Rd.
Roselle, IL 60172
630-307-3100

Matsushita Services Co.

National Parts Center
20421 84th Avenue South
Kent, WA 98032
800-833-9626

Mattel, Inc. (See INTV)**Midland International
(See Intec Global Corp.)****Mitsubishi Consumer Electronics
America, Inc.**

National Service Department
1001 Cherry Dr.
Brazelton, GA 30517
770-448-1263

NEC Technologies Inc.

Consumer Electronics Division
1275 Hamilton Pkwy.
Itasca, IL 60143-1150
630-467-5000

Nikko

AVS Technologies
2100 Trans-Canada Highway South
Montreal, Quebec
Canada H9P-2N4
514-683-1771

Nintendo of America

4820 150th Avenue NE
Redmond WA 98052
800-447-8373

Okidata

2000 Bishops Gate Blvd.
Mount Laurel, NJ 08054
800-OKIDATA

Onkyo U.S.A. Corp.

200 Williams Drive
Ramsey, NJ 07446
201-825-7950

Ortofon, Inc.

63 Mall Drive
Commack, NY 11725
516-543-6950

Panasonic Services Company

20421 84th Avenue South
Kent, WA 98033
800-833-9626

Penney, J.C.

National Parts Center
6840 Barton Road
Morrow, GA 30260
800-933-7115

**Philips Consumer Electronics
Company**

Philips Service Company
P.O. Box 555
401 Old Andrew Johnson Highway
Jefferson City, TN 37760
800-851-8885

Pioneer Electronics Service, Inc.

1925 East Dominguez St.
P.O. Box 1760
Long Beach, CA 90801
310-746-6337

Proton Corporation

13855 Struikman Road
Cerritos, CA 90703
562-404-2222

Radio Shack Business

Division of Tandy Corp.
1801 S. Beach St.
Fort Worth, TX 76105-2122
817-390-3011

Ricoh Corp.

3001 Orchard Pkwy.
San Jose, CA 95134
408-432-8800

Rotel of America

Division of Equity Int'l Inc
54 Concord St.
North Reading, MA 01864-2699
978-664-3820

Sampo Corporation of America

5550 Peachtree Industrial Blvd.
Norcross, GA 30071
770-449-6220

Samsung Electronics America, Inc.

Service Division
One Samsung Place
Ledgewood, NJ 07852
201-691-6200

Sansui USA Inc.

135 Raritan Center Pkwy.
Edison, NJ 08837-3625
732-225-6433

Sanyo-Fisher Service Corp.

1411 West 190th St
Suite 800
Gardena, CA 90248
310-769-5832

SDI Technologies

(Formerly Soundesign Corporation)
800 Federal Blvd.
Carteret, NJ 07008
800-285-4147

Sears

3333 Beverly Rd.
Hoffman Estates, IL 60179
708-286-5222
800-225-2864

Sharp Electronics Corp.

National Parts Center
1300 Naperville Drive
Romeoville, IL 60446-1091
630-226-2400

Sherwood America Corporation

14830 Alondra Blvd.
LaMirada, CA 90638-5730
714-521-6100

Shure Brothers, Inc.

222 Hartrey Avenue
Evanston, IL 60202
847-866-2200

Sony Corp. of America/

Sony Service Company
Sony Drive (T1-12)
Park Ridge, NJ 07656
201-930-1000

**Sony World Repair Parts Center
(Americas)**

8281 N.W. 107th Terrace
P.O. Box 20407
Kansas City, MO 64153
816-891-7550

Sparkomatic Corporation

(See Altec Lansing)

Studer

1449 Donelson Pike
Nashville, TN 37217
615-399-2199

Tandberg

301 Fields Lane, Bldg 2
Brewster NY 10509
914-277-3320

Tandy Services

200 Taylor St., Suite 700
Ft. Worth, TX 76102
817-339-0100

TEAC Corporation of America

7733 Telegraph Rd.
Montebello, CA 90640
213-726-0303

Technics (See Matsushita)**Teknika Electronics Corp.**

(See Fujitsu, Ltd.)

Teledyne (See Acoustic Research)**Thomson Consumer Electronics**

10330 N. Meridian
P.O. Box 1976
Indianapolis, IN 46290-1024
317-587-3000

**Toshiba America Consumer
Products Inc.**

National Parts Center
1420-B Toshiba Dr.
Lebanon, TN 37087
800-345-9785

Tote Vision

969 Thomas St.
Seattle, WA 98109
206-623-6000

Unisonic Products Corp.

1115 Broadway
New York, NY 10010
212-255-5400

Uniview

(Formerly Curtis Mathes)
100911 Petal St.
Dallas, TX 75238-2424
214-503-8880 • Fax: 214-503-8515

Videonics

1370 Dell Ave.
Campbell, CA 95008
408-866-8300

V-M Corporation

The Voice of Music
305 Territorial
P.O. Box 426
Benton Harbor, MI 49023
616-925-8841

This company no longer manufactures products, but manufactured large numbers of turntables under their own name, and for use in audio products of other manufacturers. If you ever need parts for a turntable that has 857 for the first three digits of the serial number, this is the company to contact. If you have any parts for these turntables, V-M Corporation would like to talk to you about buying them.

Wells-Gardner Electronics Corp.

2701 North Kildare Avenue
Chicago, IL 60639
773-252-8220

Yorx Electronics Service Center

302 S. Service Road West
High Hill, MO 63350
314-585-8817

Zenith Electronics Corp

201 James Record Rd., Building 3
Huntsville, AL 35824
256-774-4000

Books

***Applied Robotics*, by Edwin Wise, 312 pages, \$29.95**

A hands-on introduction to the field of robotics, this book will guide the hobbyist through the issues and challenges of building a working robot. Each chapter builds upon the previous one, extending a core robot project throughout the book. Each chapter also includes advanced information and references to other books and internet sites for further information. Examples of chapters include: Mechanical Platforms, Power Supplies, Adding Sense, Microcontrollers, Insect Robots, Pneumatics, More Behavior and Intelligence, Programming Projects, Robot Behaviors, and much more. Also included are lists of references and suppliers and an index of key concepts.

PROMPT Publications, 2647 Waterfront Parkway, E. Drive, Indianapolis, IN 46214-2041, Website: www.hwsams.com, Phone: 1-800-428-SAMS

***Guide to HDTV Systems*, by Conrad Persson, 232 pages, \$34.95**

As HDTV is developed, refined, and becomes more available to the masses, technicians will be required to service them. Up until now, precious little information has been available on the subject. This book provides a detailed background on what HDTV is, the technical standards involved, how HDTV signals are generated and transmitted, and a generalized description of the circuitry an HDTV set consists of. Some of the topics include the ATSC digital TV standard, receiver characteristics, NTSC/HDTV compatibility, scanning methods, test equipment, servicing considerations, and more.

PROMPT Publications, 2647 Waterfront Parkway, E. Drive, Indianapolis, IN 46214-2041, Website: www.hwsams.com, Phone: 1-800-428-SAMS

***Electronic Circuit Guidebook, Volume 6: Electronic Oscillators*, by Joseph J. Carr, 336 pages, \$34.95**

Electronic oscillator circuits are used to generate periodic waveforms. These waveforms may be sine waves, square waves, triangle waves, sawtooth waves, or pulses, depending on the needs of the circuit being developed. This book will teach you, in a practical and straight forward manner, how to understand and build precise electronic oscillator circuits.

PROMPT Publications, 2647 Waterfront Parkway, E. Drive, Indianapolis, IN 46214-2041, Website: www.hwsams.com, Phone: 1-800-428-SAMS

***Designing Power Amplifiers*, by Stephen Kamichik, 180 pages, \$29.95**

This book is the authority on designing power amplifiers. Hobbyists, technicians, and engineers alike will find its contents practical and useful. *Designing Power Amplifiers* is divided into two sections: Theory and Projects. The first section contains eleven chapters ranging from transformer-coupled amplifiers and push-pull amplifiers. Each chapter has questions at the end to test the reader's understanding of the material. The

second section includes easy-to-construct projects on amplifiers such as the 1, 10, and 30 watt audio power amplifiers, stereo headphone amplifier, and the 100 watt MOSFET audio power amplifier. These projects allow the reader to apply the theory learned from the first section. A detailed circuit description is given for each project. The book also includes problem solutions, a glossary, and a bibliography.

PROMPT Publications, 2647 Waterfront Parkway, E. Drive, Indianapolis, IN 46214-2041, Website: www.hwsams.com, Phone: 1-800-428-SAMS

***ES&T Audio Troubleshooting & Repair*, by ES&T Magazine, 272 pages, \$24.95**

This book presents information that will make it possible for technicians and electronics hobbyists to understand the workings of audio equipment such as CD players, power amplifiers, musical instruments, and tuners. The chapters in this book provide troubleshooting tips, theoretic analysis, general description, detailed service procedures, and more.

PROMPT Publications, 2647 Waterfront Parkway, E. Drive, Indianapolis, IN 46214-2041, Website: www.hwsams.com, Phone: 1-800-428-SAMS

Test Your Electronics Knowledge

Answers to Test (from page 19)

1. Television Receive Only
2. No. There is no number 8 in the octal system of counting. In octal, 8 is represented by 10.
3. $1.0 = 10^0$
4. Slew rate
5. Approximate bandwidth = $0.35/\text{rise time} = 0.35/0.02 \times 10^{-6} = 17.5\text{MHz}$
6. A synchronous counter
7. Choice B is correct.
8. The inductance becomes 2L. The equation in choice A is for two coils with inductive coupling.
9. Dummy load
10. A Wein Bridge circuit

Classified

Classified advertising is available by the word or per column inch.

By-the word. \$1.65 per word, per insertion, pre-paid Minimum charge is \$35 per insertion. Initials and abbreviations count as full words. Indicate free category heading (For Sale, Business Opportunities, Miscellaneous, Wanted). Blind ads (replies sent to ES&T for forwarding) are \$40 additional. No agency discounts are allowed for classified advertising by the word. Contact Alycia NicholSEN at 516-681-2922 to place your classified ad (by-the-word). Mastercard, VISA, American Express and Discover are accepted for FAX or mail orders.

Per column inch (classified Display): \$235 per column inch, per insertion, with frequency discounts available, 1" minimum, billed at 1/4" increments after that 10" maximum per ad. Blind ads are \$40 addition. Reader Service Number \$25 additional to cover processing and handling costs. (Free to 4-inch or larger ads.) For more information regarding classified display advertising, please call 630-584-5333. Optional color (determined by magazine) \$150 additional per insertion.

Electronic Servicing & Technology
25 Newbridge Rd, Hicksville, NY 11801 Attn: Classified Department
Ph: 516-681-2922 FAX: 516-681-2926

FOR SALE

WinSTIPS! — over 125,000 Current tips from repair shops! All brands. Monitor and Consumer Electronics. Search any phrase. Vcrcross, Sams, Philips Ecg. One-button update Tips. Windows 95/98 \$149.95. (CD or Web download). <http://www.kdtviwe.com>. KD TV 514 3rd St., Aurora, IN 47001. 1-888-KD-STIPS. All c/cards. Ken Hull C.E.T. **ServiceTalk** — Email group. Why work alone? 30 day free trials..

IN-CIRCUIT ESR TESTER - Find bad caps FAST and RELIABLY with the new Capacitor Wizard in-circuit ESR Tester! Great for monitors switching power supplies, TVs, etc. Only \$179.95. MC/VISA. **Independence Electronics, Inc., 800-833-1094, www.awiz.com**

PRICE REDUCTION. Diehl Mark III \$39, Diehl Mark V Horizontal circuit tester \$159. Conductive coating for remote control keypads \$9.99 ppd. **WEEC, 2411 Nob Hill Road, Madison, WI 53713. 608-238-4629. Website: <http://sites.netscape.net/duaneconger>**

RCA/Panasonic/Samsung "drop in" Power supplies, WE REBUILD \$39 flat p&l, FREE SHIPPING. Tel-Rad Service, 686 Broadway, Kingston, NY 12401. (914) 331-2812, www.telradservice.com

SCENORE, TEKTRONIX, HEWLETT PACKARD (all models). We **BUY, SELL, & TRADE.** Please call "**CHOICE ELECTRONICS**" for all of your test equipment needs. Complete financing options available. Call 1-800-609-0677, 605-361-6386 ask for Lance Tople.

CRT ADAPTER KIT — Check, Clean, Restore ALL Monitors-Projection-Color, \$59.95, **SASE, DANDY 2323 Gibson, Muskogee, OK 74403. 918-682-4286**

TV CASE HISTORIES: Volume 7 with 3,045+ histories. Satisfaction assured. Only \$59 (plus \$3.25 shipping). Over 9,640 books and supplements sold with only 1 returned for a refund! **Mike's Repair Service, P.O. Box 217, Aberdeen Proving Ground, MD 21005.** Same mailing address 35+ years. Send SASE for samples. 410-272-4984, 1-800-2-FIX-TVS 11a.m.-9p.m. (<http://mikesrs.webjumps.com>)

TEST EQUIPMENT BOUGHT & SOLD: OSCILLOSCOPES, ETC. 925-706-0177. FAX: 925-706-0156. www.oscilloscopesetc.com

*******NAP Tuner 340309******* RCA Tuner TCHRIA or TCCR1A and more. Snowy picture? **Will rebuild for \$25.00, Free Shipping!!!** **Tip Top TV & VCR, 18441 Sherman Way, Reseda, CA 91335, 818-345-1974.**

FOR SALE

****FREE** Service Tips for TV's, VCR's, Projection TV's, CAM-CORDER's. Must have IBM compatible computer. Send your Name and Address to: FREE SERVICE TIPS, P.O. BOX 464, WHEATLEY HEIGHTS, NY 11798.**

TEST EQUIPMENT FOR SALE: REASONABLE PRICES SCENORE, TEKTRONIX, HP and MUCH MORE. View complete list at: <http://www.astglobal.com> or contact: **AST GLOBAL ELECTRONICS.** Voice: 888-216-7159; Fax 814-398-1176; e-mail: sales@astglobal.com

All VCR Drop In Power Supplies Rebuilt, \$29.95. Free Shipping. Liberty Electronics, 207 W. Clinton Avenue, Oaklyn, NJ 08107. 856-854-4443. E-mail jkliberty@aol.com

OSCILLOSCOPES. Used \$50.00 and up. New 20 MHz Tektronix \$275.00, new 40 MHz B&K \$400.00, new 100 MHz Hitachi \$800.00. Lots more. Full line of new and used test instruments. Free catalog. **GEOMA, 601 Academy St., Elroy, WI 53929 Tel (608) 462-4222.**

BUSINESS OPPORTUNITIES

CENTRAL FLORIDA TV/ELECTRONICS Business/Building. Heart of the retirement area. 36 years (75K). Owner retiring. **941-385-0359.**

ELECTRONIC SERVICE CENTER For Sale. Metro Detroit Area. Established over 30 years. (50K) 734-728-0618.

TV-STEREO-VCR SATELLITE-ANTIQUE RADIO-ELECTRONICS PARTS BUSINESS. Owner established over 32 years in a beautiful retirement community. 30 minutes from Olympia, Washington state capital. Busy, profitable 4-man shop needs talented owner who loves serving others with integrity and quality. A unique business with excellent growth potential. **360-482-3283.**

WANTED

WANTED:USED TEST EQUIPMENT. TURN IDLE OR EXCESS EQUIPMENT INTO CASH. AST GLOBAL ELECTRONICS. Voice: 888-216-7159; Fax 814-398-1176; e-mail: sales@astglobal.com.

Reader's Exchange

Readers' Exchange is a free service.

The following restrictions apply to Readers' Exchange:

- Only individual readers may use Readers' Exchange, and items must be restricted to those that are ordinarily associated with consumer electronics as a business or hobby. If you're in business to sell the item(s) you want to offer for sale, the appropriate place for your message is in a paid advertisement, not Readers' Exchange.
- Readers' Exchange items must be restricted to no more than three items each for wanted and for sale.
- All submissions must be typed or printed clearly!

**Send your Readers' Exchange submissions to:
Readers' Exchange, Electronic Servicing & Technology, 25 Newbridge Road, Hicksville, NY 11801**

FOR SALE

Sencore VA48 TV-Video analyzer. \$100.00. Sencore CR13A CRT tester, \$75.00. Both in excellent condition and come complete with plugs, cables, and manuals. Shipping not included. *Contact: Baros TV Service, 6113 Isleta Blvd. SW, Albuquerque, NM 87105, phone: 505-877-5688.*

Series book TE8 and TR 16 tape recorder. Sams Photofacts. *Contact: Ann Bichanich, 15 W. Lake Street, Chisholm, MN 55719, phone: 218-254-4421.*

Sencore SG165 AM-FM stereo analyzer. excellent condition, all probes, manual, \$250.00. Shipping not included. *Contact: Patrick Willie, P.O. Box 933, Ft. Defiance, AZ 86504, phone: 520-871-2139.*

Ghirardi's 1st edition Modern Radio Servicing w/dust cover. \$35.00. Radio Handbook, 7th edition. \$25.00. Ghirardi's Radio Troubleshooters Handbook, 3rd edition, \$35.00. Elements of Radio Marcus and Horton, good copy, \$25.00, slightly damaged copy. \$10.00. Audel's Radiomans Guidebook. \$15.00. 30 NRI lessons for \$18.00. Lot #1 -25 old type radio tubes. No boxes 4-5-7 pins, \$35.00. Lot #2-50 used TV-radio tubes assorted. \$40.00. Lot #3 35 used radio tubes. 4, 5, 7 pin. \$45.00. 2 lots 100 assorted TV radio tubes. mostly N.O.S., \$50.00 each, both for \$90.00. Shipping not included. *Contact: Maurer TV Sales, 29 South 4th Street, Lebanon, PA 17042.*

Ramsey Pager test equipment including service monitor, encoder, oscilloscope, crystal checker, radiation test fix, SINAD meter, preamp probe, cabling and manuals. Mint condition, \$5000.00. Shipping included. *Contact: Shirley, 702-435-3201.*

WANTED

Howard Sams Photofacts, Series #1981 through 2165. *Contact: Ken Richardson, 730 Edgefield Rd., North Augusta, SC 29841, phone: 803-278-1040,*

AKAI-A301 audio stereo receiver. Need the schematic and parts list. Manual is no longer available from the manufacturer. Will buy or copy and return. *Contact: Don Schaefer, Donald@mlsipc.com*

Navy impedance bridge 2M 11V working or not. *Contact: Sidney, 510-357-3788.*

Tele-Matic color TV test jig 10J106C or newer. *Contact: Ross Factory Service, 123 Farsworth Avenue, Bordertown, NJ, phone: 609-298-1106.*

Toshiba Model M-5420 VCR front panel circuit board w/power, rew. eject buttons. *Contact: Bill Shillingford, 1128 First Ave., Croydon, PA 19021.*

**ONLY
\$4.00
per issue**

**ORDER
TO
BACK
ISSUES**

ELECTRONIC
Serving the technician

How antenna work
Understanding SCS
Managing a service center

**COMPLETE YOUR
COLLECTION TODAY!**

When ordering back issues include the following information: Name, address, city, state & zip. Please make a list of the issues you're requesting. When paying by credit card send the number along with the expiration date. Check, Money Order, Master-card, VISA, Discover and AMEX accepted.

**For Fastest Service
Fax 1-516-681-2926
Electronic Servicing & Technology
25 Newbridge Road
Hicksville, NY 11801**

Do You Repair Electronics?

Repair Databases for
TV, VCR, Monitor, UL
Audio, FCC, and more.

- Over 76,000 records
- Private user forums
- Live on-line chat rooms

RepairWorld.com

Electronic Corp 1 Herald Sq, Fairborn, OH 45324 (937) 878-9878

Circle (65) on Reply Card

Monitor Test Equipment

www.computermonitor.com

- Sweep rates to 64kHz
- Gray Scale/Color Bars
- "AutoScan" (auto rate switching)
- Portable & Bench units
- Patented



CMM 1-800-466-4411, 770-662-5633
Visa-MC-AMX-Discover—On-line ordering

Circle (63) on Reply Card

VANCE BALDWIN Original Parts!
Printer Consumer Fax
ELECTRONICS

Pricing!
Availability!
Research!
Place Orders!

E-Parts Online
Electronic Parts Online

www.vancebaldwin.com

Circle (70) on Reply Card

Visit the NEW
Herman Cyberwarehouse
to order online now!



HERMAN
ELECTRONICS

www.hermanelectronics.com

Telenetics Rapid Quality Service
Since 1983

Your Test Equipment

Repaired (800) 531-2680 Calibrated

Over 15,000 models serviced
ISO9000 Traceable
www.teleninc.com
meters, scopes, counters, etc, etc.

Circle (68) on Reply Card

The nation's
one source for brand name
electronics parts, accessories
and literature from

a to z

Tritronics
INCORPORATED

aiwa PHILIPS
Bosch Crocker RCA
DENON SANYO
FISHER GENERAL ELECTRIC
HITACHI SHARP
JVC SONY
MAGNAVOX TOSHIBA
Panasonic WELBILT
ZENITH

1-800-638-3328
1-800-888-FAXD

Circle (69) on Reply Card

Advertisers' Index

Company	Page Number	Reader Service Number	Advertiser Hotline
B & D Enterprises	3	60	888/815-0508
B & K Precision	26	62	714/237-9220
CES	IFC	113	703/907-7670
Computer & Monitor Main	64	63	800/466-4411
Electronic Design Specialist	39	64	561/487-6103
Electronics Technicians Assoc.	43	72	800/288-3824
Electronix Corporation	64	65	937/878-1828
Herman Electronics	64		800/938-4376
Iscet	10	75	817/921-9101
Pomona Electronics	25	116	909/469-2900
Sams & Company, Howard	40	66	800/428-SAMS
Sencore	23	7	800/736-2673
Telenetics	64	68	800/531-2680
Thomson Consumer Elec	BC	67	800/336-1900
Tritronics, Inc.	64	69	800/638-3328
Vance Baldwin	64	70	800/432-8542

We'd like to see your company listed here too. Call Kaprelian & Company at 630-584-5333 Ext 18 to work out an advertising program tailored to suit your needs.

What's Your Best Servicing Value?

The magazine that makes money for you -

ELECTRONIC

Servicing & Technology



Each month, **ES&T** brings you how-to service articles on TVs...VCRs... Computers... CD players... Microwave ovens... Audio products and more. It's the information you need to do your job everyday.

Regular columns and special features from experts will make you more efficient - and more profitable - in no time. Plus, our monthly PROFAX, a FREE 8-page pull-out of popular TV, VCR and computer schematics, makes **ES&T** an even greater value.

1-year, (12 issues) \$26.95 2-years, (24 issues) \$49.95
1-year Canada/Mexico \$36.95 2-years, Canada/Mexico \$69.95
1-year Foreign Air Post, \$44.95 2-years Foreign Air Post, \$85.95

Electronic Servicing & Technology

25 Newbridge Road, Hicksville, NY 11801 • Phone: 516-681-2922 • FAX: 516-681-2926

Video Heads Pick A Number Any Number

When you're looking for a replacement head, SK Series is way ahead of the competition.

SK Series replacement video heads cross over to 4,500 different models and 68 different brands.

And when you're in need of any exact semiconductors, belts, tires, flyback transformers or video replacement parts, we have them too.

But we don't stop there.

Every SK Series product comes with the quality assurance and accuracy you expect from all Thomson products.

For more information on SK Series products, contact your nearest Thomson Distributor.

SK Series...The parts you need to do the job. "Trust me!"



THOMSON CONSUMER ELECTRONICS

SK

Series

Circle (67) on Reply Card